

**Data Sheet and Instruction Manual**

**DE44 | Digital 2-Channel Differential Pressure Switch / Transmitter**

**DE44#####KS###**

**Dust Explosion Proof to Zone 22, dry dust**

**Table of Contents**

1. Safety Instructions
2. Intended Applications
3. Product Description and Functions
4. Installation
5. Commissioning
6. Maintenance
7. Transport
8. Service
9. Accessories
10. Disposal
11. Specifications
12. Dimensions
13. Ordering Code
14. Declaration of Conformity

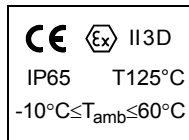
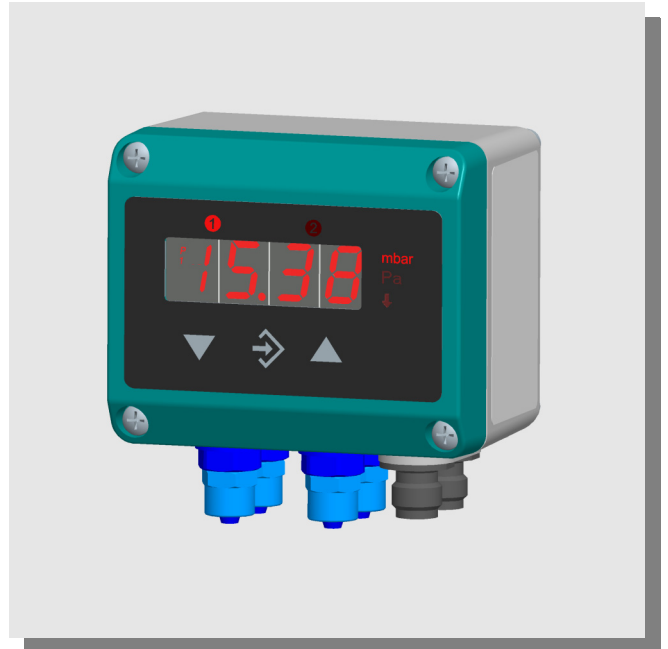

**1. Safety Instructions**

**1.1. General**



This manual contains detailed information about the product and instructions for its installation, operation and maintenance.

Operators and other technical personnel responsible for the equipment must read this thoroughly before attempting to install or operate this equipment. A copy of this manual must always be kept accessible at the place of work for reference by concerned personnel.

Chapter 1 (sections 1.2 through 1.7) contains general as well as specific safety instructions. Chapters 2 through 10, covering topics ranging from intended purpose of the equipment to its final disposal, also include important points relating to safety. Overlooking or ignoring any of these safety points can endanger humans and animals, and possibly cause damage to other equipment.

**1.2. Personnel Qualification**

Personnel responsible for installation, operation, maintenance and inspection of this product must have the qualifications, training and experience necessary to carry out such work on this type of equipment.

Qualified personnel are people who are able to judge delegated work and possible dangers due to technical education, proficiency and experiences and especially by knowledge about the relevant norms.

When working with explosion proof constructed instruments personnel needs to be educated or instructed resp. have the authorisation to work with explosion proof instruments in explosion-hazardous plants.



### 1.3. Risks of Disregarding Safety Instructions

Disregarding safety instructions, use of this product for purposes for which it is not intended, and/or operation of this product outside the limits specified for any of its technical parameters, can result in harm to persons, the environment, or the plant on which it is installed. Fischer Mess- und Regeltechnik GmbH will not be responsible for consequences in such circumstances.

### 1.4. Safety Instructions for Operators

Safety instructions for the proper use of this product must be followed. This information must be available at all times by personnel responsible for installation, operation, maintenance and inspection of this product. Adequate steps must be taken to prevent the occurrence of hazardous conditions that can be caused by electric energy and the convertible energy of the process media. Such conditions can, for example, be the result of improper electrical or process connections. Detailed information is available in relevant published norms (DIN EN, UVW in Germany; and equivalents in other countries), industrial standards such as DVWG, Ex-, GL-, VDE guidelines, as well as regulations of the local authorities (e.g., EVUs in Germany).

The instrument must be put out of action and protected against accidental use if safe operation can not be guaranteed anymore. A reason for this might be one of the following incidents:

- apparent damage of instrument
- failure of electrical function
- longer storage periods at temperatures higher than 85°C
- bad packaging during transport

Repairing is only allowed to be done by Fischer Mess- und Regeltechnik GmbH.

Before the instrument is put into operation again a professional routine test acc. to DIN EN61010, part 1 needs to be done. This inspection should necessarily be done by Fischer Mess- und Regeltechnik GmbH. Appropriate transport and professional storage of instrument are understood.

### 1.5. Modifications Forbidden

Modification or other technical alteration of the product is not permissible. This also applies to the use of unauthorized spare parts for repair / maintenance of the product. Any modifications to this product, if and as necessary, should be done only by Fischer Mess- und Regeltechnik GmbH.

### 1.6. Operational Restrictions

The operational reliability of the product is guaranteed only when used for intended purposes. The product must be selected and configured for use specifically with defined process media. The limiting values of operating parameters, as given in the product specification sheet,

must never be crossed.

### 1.7. Safety Considerations during Installation and Maintenance

The safety instructions given in this manual, existing national regulations relating to accident prevention, and the internal safety rules and procedures of the user organization regarding safety during installation, operation and servicing must all be followed meticulously.

It is the responsibility of the users to ensure that only suitably qualified and experienced technical personnel are used for installation, operation and servicing of this equipment.

## 2. Intended Applications

Display and limit detection of differential pressure of gases. The product must be used only for applications and under conditions specified by the manufacturer.

Classification of Explosion-Hazardous Area

2-Channel Differential Pressure Switch / Transmitter DE44 is suitable as „electrical equipment for use in explosion-hazardous areas (flammable dust)“, zone 22, dry dust.

Declaration per Directive 94/9/EC (ATEX)

⊕ II 3D IP65 T125°C

## 3. Product Description and Functions

### 3.1. Functional Scheme

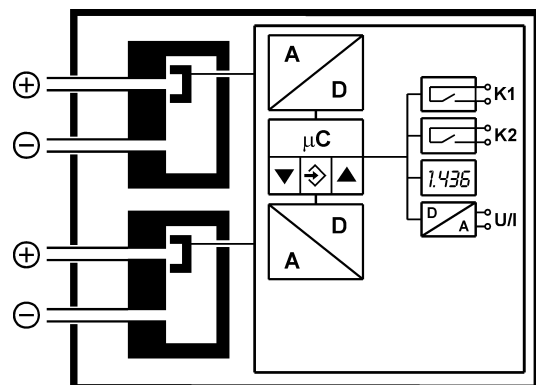

### 3.2. Principles of Operation

The instrument is based on dual piezo-resistive sensor elements, each of which can measure positive gauge, negative gauge (vacuum) or differential pressure. The pressure is measured directly by a piezo-resistive resistance bridge that is formed on the surface of an integral silicon diaphragm in each sensor. Change of pressure results in change of resistance that is converted to a varying voltage and then digitized. The instrument's internal microcontroller transfers the measured value on the LED display, controls the two limit detection switches, and optionally transmits the measured value through an analogue conversion stage as a voltage or current signal

output. The output of sensor 1 is used by limit switch 1 and also by the optional transmitter output. The output of sensor 2 is used only by limit switch 2.

## 4. Installation

The electronic module is mounted on a flat plate or panel, for which it has 4 holes at the rear for self-tapping screws  $\varnothing 3.5$  mm.

A wall-mounting rear adaptor plate is available as an option (s.13. Ordering Code).

The pressure transmitter is factory calibrated while mounted vertically, pressure ports downward. However, it can be mounted in any orientation. If it is installed with any orientation other than vertical (pressure ports downward), the zero point must be re-set (s. 5.3.3.).

IP65 protection for the housing is guaranteed only if suitable connecting cable is used.

### 4.1. Process Connection

- Only qualified technicians authorized for this type of work should undertake installation.
- Ensure that process equipment and pressure lines are at atmospheric pressure before making pressure connections.
- The instrument should be provided with suitable protection against pressure surges (e.g., snubber or pulsation damper).
- Ensure that the mechanical configuration and materials of construction of the instrument are compatible with the process media.
- Ensure that process pressure is always less than the specified safe pressure rating.
- Carefully check the pressure-tightness of all pressure connections before start-up.



### 4.2. Electrical Connection, Safety Precautions for Explosion Prevention

- Only qualified technicians authorized for this type of work should undertake installation.
- Switch off electrical power to the plant before attempting electrical installation work of any kind.
- Do not disconnect plug live wire.
- To ensure safe operation supply wiring system must meet specifications for zone 22, class 3. Electrical connections must comply with relevant international and local regulations and norms relating to electrical and instrumentation installations in hazardous areas (e.g.: EN 50281-1-2).
- Operating supply voltage (24 V DC/AC) must not

excess 32 V DC/AC - neither per temporary interferences! Supply wiring system must be protected by Si 315 T.

- For recommended current supply see 11. Specifications.
- Parametrisation by PC serial interface adaptor EU03.F300 is permitted only in safe areas outside explosion-hazardous areas zone 22.

## 5. Commissioning

- Power supply and signal cabling to the instrument must be correctly selected to meet operational requirements and installed in a way that does not cause physical stress to the instrument.
- Pressure lines must have a downward gradient throughout from the pressure instrument to the process vessel / pipe. This is to prevent formation of air / gas pockets (for liquid applications) and liquid plugs (for air / gas applications). If this continuous downward gradient cannot be provided for any reason, then suitable water and / or air separation devices must be inserted into the pressure lines.
- Pressure lines must be kept as short as possible and must not have short bends to avoid measurement errors induced by pressure line delays.

### 5.1. Pressure Connections

The instruments pressure ports are marked by "+" and "-" symbols. For differential pressure applications the "+" port must be connected to the higher pressure and the "-" port should be connected to the lower pressure.

If the pressure transmitter is subjected to pressure when it is started up, zero point checking and adjustment is not possible. In such cases, only electrical connections of the instrument should be made, but not the pressure connections.

### 5.2. Display



The 3½ digit LED display normally indicates the current differential pressure. The backlit symbols P1 and P2 to the left of the 3½ digit LED display indicate the display function (s. 5.3.2.). The backlit symbols to the right of the 3½ digit LED display indicate the unit of pressure measurement. (Note: the units shown in the illustrations of this

document can be different from those of the actual instrument). The two LED lamps above the 3½ digit LED display respectively indicate the status of the two limit relays / solid-state switches ① ② (LED on = relay contacts closed / solid-state switch on).

While the instrument is in set-up mode, the 3½ digit LED display either indicates the selected menu option or a set-up parameter value. The instrument continues its pressure monitoring functions even while it is in set-up mode, except under either of two circumstances.

One is when the limit switching delay time is changed: the existing delay must time out first. The other is when the look-up table (for conversion of measured values) is re-programmed (s. 5.3.8.). In these circumstances, the output signal value and the limit relay/switch states are frozen until the changes are finalized.

### 5.3. Set up

The instrument has comprehensive set-up options by means of which it can be optimized for any specific measuring or control application. This section of the document provides information and instructions about each of the set-up parameters.



Depending on the instrument configuration ordered (e.g.: without transmitter signal output / with voltage signal output / with current signal output) some of the menu options may not be available.

Some set-up parameters may be consequentially excluded. For example, if the instrument is ordered without a transmitter output, all signal conversion programming options are omitted in the set-up menu (s. 5.3.7. Signal Conversion and Transfer Functions).

All instrument settings can be conveniently done from a PC connected to the instrument through a serial interface adaptor. All set-up parameters can be viewed and changed on the PC screen. Also, the entire instrument set-up configuration can be loaded, stored on the PC's hard disk drive, and printed out for plant / process documentation purposes. Further information about this PC software is given in the related manual.

#### 5.3.1. Selecting the Unit of Pressure Measurement

Make the necessary electrical connections (signal, power supply) to the instrument. Its pressure sensor/s must be pressure-free (i.e., vented to atmosphere; typically by disconnecting the pressure line/s).

The current valid unit of measurement is indicated by one of the backlit symbols to the right of the digital display. To change the unit of measurement, first press  $\diamond$  then search for parameter *Ein* using  $\blacktriangle$ . Next press  $\diamond$  again and select another unit of measurement using  $\blacktriangle$  or  $\blacktriangledown$ . Then press again  $\diamond$  to store the selection, and *Ein* will appear again in the digital display.

To exit the set-up mode, press  $\blacktriangledown$  until *ESC* appears, and

then press  $\diamond$ . The current pressure measured value is indicated again, and the appropriate symbol of the unit of measurement (to the right of the digital display) is lit.



The digital display is limited to a count of  $\pm 1999$ . Therefore all the available units of measurement may not be suitable for selection for a given application.

#### 5.3.2. Display Settings

Because the DE44 has two independent measuring channels, a user can command the instrument to display any one channel continuously, or both alternating. For this, the *dSP* parameter is set to either the first channel (*dSP* = 0.0) or the second channel (*dSP* = 0.1), or both channels alternating with a user-programmable display time for each channel (*dSP* = 0.2 to 99.9 secs per channel). The backlit symbols P1 and P2 to the left of the digital display indicate which channel's measurement is currently displayed.

Setting a channel display time of about 3 seconds gives the user sufficient time to comfortably read the measurement, yet avoid the need to manually switch the display between P1 and P2.

#### 5.3.3. Zero Point Checking and Adjustment

If the instrument has been de-pressurized (vented to atmosphere) and does not indicate precisely zero, note this non-zero value. Using the set-up parameter *oFl*, you can trim this offset to exactly zero. If the indicated non-zero value is positive, this value must be entered and stored as a negative offset value, and vice versa.



If the instrument was in use before zero setting is done, values of set-up parameters *oFl* and *nP* would have been previously programmed. In this case, set both values to zero, read the actual zero offset, and then use this value for *oFl* for zero point correction, as described in the previous paragraph.

Note: The registered value is a pure number: no decimal point is indicated.

After correcting the zero offset, the pressure connections can be made again.

Because the DE44 has two independent measuring channels, zero offset correction has to be made for the second channel (*oFl2*) exactly in the same way as for the first (*oFl*).

#### 5.3.4. Damping and Zero Stabilization

If the media is subject to excessive pressure fluctuations, the displayed readings and the transmitter output signal can be stabilized using the instrument's *dAn* and *nP* set-up parameters.

The set-up parameter *dAn* has the effect of a pulsation damper (on the displayed measurements, output signal



and limit detection, - not on the sensor itself!). It adds a time-constant (averaging filter) in the user selectable range of 0.0 to 100.0 secs. When the damping is set to maximum, it takes more than 2 minutes to reach the final value for a full scale pressure jump.

In many cases fluctuating pressure readings do not cause a problem, except when the plant / equipment is at zero (differential) pressure condition and readings fluctuate near about zero value. The set-up parameter  $nP$  is meant to take care of this. Its value defines the number range across zero (similar to the zero offset correction number), within which the measured value is forced to zero. If a value of 8 is set for  $nP$  any pressure measurement in the range -0.08 to +0.08 mbar (or -8 to +8 Pa) displayed as zero. Only when the actual pressure is outside this range will the display indicate a non-zero value. The actual and displayed pressures will agree starting from double the value of the  $nP$  setting (in the given example: 0.16 mbar or 16 Pa).

### 5.3.5. Output Signal Setting

The transmitter output signal depends primarily on the measured pressure. However, this signal can be adapted to meet users' application requirements precisely. The basic pressure range (as marked on the product identification label) and the type of output signal (voltage or current) always remain unchanged for a particular instrument unit.

The set-up parameters  $NR$  (measuring range starting point) and  $NE$  (measuring range end point) specify the pressure values between which the measurements are expected to be. Both values can be selected anywhere within the specified measuring range of the instrument (e.g., 400 Pa). This user-programmed pressure range will correspond to the output signal (current or voltage) range, which will be as specified on the product identification plate: i.e., 0 - 10 V or 4 - 20 mA. If  $NR$  is lower than  $NE$ , the signal is said to have a positive slope: i.e., the output signal increases as the pressure increases. If  $NE$  is lower than  $NR$ , the output signal has a negative slope: i.e., the output signal decreases as the pressure increases.

The difference between the values of  $NR$  and  $NE$  must be at least 25% of the specified measuring range of the instrument (100 Pa for 400 Pa instrument example mentioned above). The software does not permit a smaller pressure span to be entered (the instrument will not allow storing of, nor exit from an invalid span).



Note: If you change  $NR$  and/or  $NE$  the look-up table (s .5.3.7., 5.3.8.) that existed up to that instant is deleted!

### 5.3.6. Output Signal Limiting (Namur)

The three set-up parameters  $oG1$ ,  $oG2$  and  $oEr$  specify the limits of the signal output current or voltage that are

not to be exceeded, irrespective of the actual pressure. These limit values have higher priority than the  $NR$  and  $NE$  pressure span settings.

These settings serve mainly to prevent control systems from interpreting brief pressure excursions outside the measuring range as error / fault events.  $oG1$  sets the output signal minimum value, and is useful only for a 4 - 20 mA current signal, because sometimes a value below 3.8 mA is defined as a sensor fault condition.  $oG2$  sets the upper signal limit and is valid for either current or voltage signal (e.g., voltage signal output can be limited at 10.2 V).

An instrument fault condition can be transmitted as an output signal value set as parameter  $oEr$ . However, it should be understood that not all instrument fault and error conditions can be detected and signaled by the self-diagnostic functions of the instrument!

### 5.3.7. Signal Conversion and Transfer Functions

In certain cases other process variables are derived from primary pressure measurement. Examples are flow rate derived from differential pressure across an orifice plate, and liquid level derived from hydrostatic pressure of liquid measured at the bottom of the tank. Such derivations often involve non-linear transfer functions, while it is necessary for the output signal to be linearly proportional to the derived variable (e.g. liquid volume in a tank in  $m^3$ , or flow rate in  $cm^3/sec$ ).

The set-up parameter  $F$  allows the user to select the appropriate signal conversion function from those available:

- $F = 0$ : Linear characteristic (default)
- $F = 1$ : Square root extraction
- $F = 2$ : Horizontal cylindrical tank
- $F = 3.....30$ : Look-up table with 3 to 30 pairs of values

The tables generated by functions  $F = 0$ ,  $F = 1$  and  $F = 2$  are not visible. For these functions, internal values are used for table computation. These values cannot be modified by the user.

For all conversion functions, when the actual pressure is equal to the  $NR$  value, the output signal will be at the lowest end of its range (0 V, 0 mA or 4 mA). When the actual pressure is equal to the  $NE$  value, the output signal will be at the highest end of its range (10 V or 20 mA). The user can enter only the 1...28 intermediate values of the look-up table function  $F = 3.....30$ . The parameters  $NR$  and  $NE$  relate to the start and end values of the look-up table. A change in either of these parameter values causes the conversion function to be re-set to  $F = 0$ .



Whenever the value of  $F$  is changed, the instrument internally generates a new look-up table. All previous table values are deleted and replaced by new linear progression values.

### 5.3.8. Look-up Table Programming (F = 3..30)

If the value of set-up parameter **F** is selected equal to or greater than 3, a sub-menu **Lin** is invoked. Through this sub-menu all the required look-up table values can be entered, except the first and last pairs of table values (respectively corresponding to **NR** and **NE**). This sub-menu has its own entry and exit points, the latter being the last of the value pairs to be entered. The table is stored only when the user exits to the sub-menu prompt **Lin**, by pressing **↵**. If the table is not correctly entered, the display will indicate **Err**, indicating an error condition. If this happens, it is not possible to exit this sub-menu mode until the error is corrected.

The table entries consist of 1 to 28 pairs of values. Values **i02** through **i29** (or **u02** through **u29**) specify the amplitude of the signal output, and the values **P02** through **P29** are the corresponding pressure values.

Entering or changing table values through the instrument's membrane keyboard is a tedious and error-prone method. It should only be used as a stopgap method when a PC and/or the PC Interface Module is not available.

The table is accepted as correct if each output value is larger than its preceding value. Pressure values can be steadily increasing or steadily decreasing. However, a transition from falling to rising pressure values is not permitted; nor are pressure values allowed to turn back along the same curve.

### 5.3.9. Limit Setting

The two limit switching outputs **1** **2** (relay contacts or solid-state switches) are each configured by four set-up parameters:

Switching output 1 is configured by parameters **r1A**, **r1E**, **r1d** and **r1F**.

Switching output 2 is configured by parameters **r2A**, **r2E**, **r2d** and **r2F**.

The turn-on and turn-off points of switching output 1 are defined respectively by parameters **r1A** and **r1E**. The values for these are set in the currently valid unit of measurement (indicated by the lighted symbol to the right of the digital display).

The two parameters **r1A** and **r1E** together determine the logic of switching output 1:

If **r1A** is smaller than **r1E**, the output turns on when the measured value exceeds **r1E**. It turns off again only when the measured value falls below **r1A** (hysteresis function).

If **r1A** and **r1E** have the same value, there is no hysteresis: the switching output turns on when the measured value exceeds **r1A / r1E**, and turns off again when the measured value falls below **r1A / r1E**.

If **r1A** is larger than **r1E**, the switching output turns on when the measured value falls between **r1A** and **r1E**: i.e., when  $r1E < \text{measured value} < r1A$  (window limit function).

Both parameters can be independently adjusted over the full measuring range.

If the unit of measurement is changed, the switching points are changed accordingly. In this event, rounding error can cause a deviation in the least significant (right-most) digit.

The value of the set-up parameter **r1d** determines the delay time for switching output 1, after the measured value reaches the switching point. The delay value can be selected in the range 0.0 to 100.0 secs. This value applies equally to turn on and turn off.

The set-up parameter **r1F** determines the action of the switching output. If **r1F** = 1, the switching output acts as normally open (NO) contacts. If **r1F** = 2, it acts as normally closed (NC) contacts.

### 5.3.10. Password

The last set-up parameter allows a password to be entered. A password value of 001 to 999 can be selected. A value of 000 disables the password function.

If a password was set previously the digital display indicates **PAS** after **ESC** is displayed and **↵** is pressed. The password is then entered, by pressing **↵** and then **▲**, **▼**. Only then will the set-up menu options be accessible. If an incorrect password is entered, the display jumps back to beginning of the menu (i.e., **ESC**).

### New Functions! (as of April 2008)

#### 5.3.11. d0 – Display options

This parameter allows smoothing the displayed values in cases where they are frequently deviating. The filter function is similar to the **dAN** function, but acts only upon the display, having no impact on the output signal. Additionally the display can be turned off partially (**d0** = -1, only the setpoint LEDs are driven) or completely (**d0** = -2).

#### 5.3.12. rES – Reset to default values



This function will reset all parameters to default when activated. Default values can be defined only by using the PC interface.

#### 5.3.13. NAF, NEF, dPF – Free Unit

If the device is configured to have a "free" third unit (symbol: **▼**) then the display can be scaled as desired by using these three parameters.

The measuring range as defined by parameters **NR** and **NE** is rescaled to **NAF** and **NEF**. If the table function (**F**) is enabled, table values will be taken into account too. The **dPF** value controls the position of the decimal point.

#### 5.4. Overview of Set-up Parameters

When the instrument is turned on, it briefly displays the software version number, and then switches automatically to normal operating mode. Pressing  causes the set-up menu to be called up, indicated by **ESC** on the digital display. After that, by pressing  repeatedly, each of the set-up parameters is called up in sequence:



**Note: Depending on the version of the instrument that was ordered, some of the individual parameters might not be available.**

- **PAS** Password input (appears only if password value is not zero). Values: 001 to 999
- **dSP** Selection of unit of measurement.
- **dAN** Damping (time constant). Range of values = 0.0 to 100.0 secs
- **dO** Damping (display only), range of values 0..100. Additional: -1 = no digital value and -2 = display turned off completely.
- **rIA** Switching output 1: turn-off point.
- **rIE** Switching output 1: turn-on point.
- **rId** Switching output 1: delay. Range of values = 0.0 to 100.0 secs. This value applies equally for turn-on and turn-off delays.
- **rIF** Switching output 1 action. If **rIF** = 1, acts as NO contacts. If **rIF** = 2, acts as NC contacts.
- **r2A** Switching output 2: turn-off point.
- **r2E** Switching output 2: turn-on point.
- **r2d** Switching output 2: delay. Range of values = 0.0 to 100.0 sec. This value applies equally for turn-on and turn-off delays.
- **r2F** Switching output 2 action. If **rIF** = 1, acts as NO contacts. If **rIF** = 2, acts as NC contacts.
- **Ein** Unit of measurement. The selection is indicated by the backlit symbol to the right of the digital display. A particular unit can be selected only if it can be meaningfully represented within the basic measuring range of the instrument.
- **NA** Measuring range start point. The value of the measured variable corresponding with the minimum value of the output signal (0 V, 0 mA or 4 mA, depending on the instrument version).
- **NE** Measuring range end point. The value of the measured variable corresponding with the maximum value of the output signal (10 V or 20 mA, depending on the instrument version).

- **dPF** Position of decimal place for free unit.
- **NAF** Measuring range start point (displayed value) for free unit.
- **NEF** Measuring range end point (displayed value) for free unit.
- **nP** Zero stabilization. Range = 0 to 100 counts. The value spans symmetrically around the actual zero point.
- **oFI** Zero offset correction, input 1. Range = -100 to +100 counts.
- **F** Signal conversion function. (0 = linear, 1 = square root, 2 = horizontal cylindrical tank, 3..30 = look-up table)
- **Lin** Look-up table entry (sub-menu)
- **oGI** Output signal limiting, minimum
- **oG2** Output signal limiting, maximum
- **oEr** Fault signaling (output signal value on detection of instrument fault).
- **rES** Reset all values to default. (Default values can be defined only by using the PC interface.)
- **-P-** Password setting. Permissible password values = 001 to 999. "000" disables password protection.



**If the password is lost, the instrument can be unlocked only through a serial interfaced PC, or the instrument has to be sent to the manufacturer for this purpose.**



If **oGI** and **oG2** are both set to "0", the output signal will not be subjected to limiting.



If **oGI** is set at the maximum value (11 V or 21 mA), the output signal can be adjusted using **oG2** to any arbitrary value between zero and maximum value, irrespective of pressure measurement. This feature enables the instrument to be used as a simulated signal source to test signal lines and other instruments or systems.

## 5.5. Electrical Connections, Switching Outputs

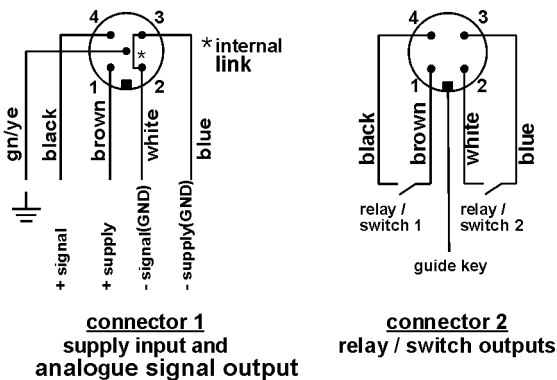

### Switching Outputs:

Switching output 1 is configured by parameters  $rIR$ ,  $rIE$ ,  $rId$ , and  $rIF$ .

Switching output 2 is configured by parameters  $rIR$ ,  $rIE$ ,  $rId$ , and  $rIF$ .

### Power Supply Voltage and Output Signal Load:

Nominal supply voltage and the operating supply voltage range and the maximum output signal loads are indicated under 11. Specifications.

The signal ground line is internally connected to the instrument ground, and serves only as an alternative ground connection for the output signal. This usually increases the noise margin.

## 6. Maintenance

The instrument is inherently maintenance-free.

However, to ensure reliable operation and maximize the operating life of the instrument, it is recommended that the instrument, its external electrical and process connections, and external connected devices be regularly inspected, e.g.:

- Check the display.
- Check the switching function in connection with external devices.
- Check all pressure connections for leak-tightness.
- Check the integrity of all electrical connections of the instruments.

Inspection and test schedules depend on operating and site conditions. The operating manuals of other equipment to which the transmitter is connected must be read thoroughly to ensure that all of them work correctly when connected together.

## 7. Transport

The product must be protected against shock and vibration during transport. It must therefore be properly packed, preferably in the original factory packaging, whenever it is to be transported.

## 8. Service

Any defective devices or devices with missing parts should be returned to Fischer Mess- und Regeltechnik GmbH. For quick service contact our service department.



Remaining medium in and on dismantled measuring instruments may cause danger to persons, environment and equipment. Take reasonable precautions! Clean the instrument thoroughly if necessary.

## 9. Accessories

See 13.1.

## 10. Disposal



*Protect your environment!*

Use the product in accordance with relevant regulations. Please be aware of environmental consequences of disposal at the end of the product's life and take care accordingly.



## 11. Specifications

### 11.1. General

Two independent differential pressure sensors

Measuring range	mbar	0-4	0-6	0-10	0-16	0-25	0-40	0-60	0-100	±2,5	±4	±6	±10	±16	±25	±40	±60	
	Pa	0-400	0-600	0-1000	0-1600					±250	±400	±600	±1000	±1600				
	kPa	0-0.4	0-0.6	0-1.0	0-1.6	0-2.5	0-4.0	0-6.0	0-10.0	±0.25	±0.4	±0.6	±1.0	±1.6	±2.5	±4.0	±6.0	
Max. static operating pressure	mbar	50		100		250		500		50			100		250		500	
Max. safe pressure	mbar	150		300		750		1500		150			300		750		1500	
Straight line error (max.)°	%FS	1.0																
Straight line error (typ.)°	%FS	0.5																
Tc span (max.)°°	%FS 10K	1.0		0.3				1.0		0.5		0.3						
Tc span (typ.)°°	%FS 10K	0,3																
Tc zero point (max.)°°	%FS 10K	1.0		0.4				1.0		0.5		0.4						
Tc zero point (typ.)°°	%FS 10K	0.2																

° Straight line error = nonlinearity + hysteresis; at 25 °C; pressure within specified range (characteristic linear, not spreaded)

°° Pressure within specified range (characteristic linear, not spreaded); compensated temperature range 0 to 60 °C



Operating temp. (ambient)  $-10^{\circ}\text{C} \leq T_{\text{amb}} \leq 60^{\circ}\text{C}$   
 Operating temp. (media)  $-10^{\circ}\text{C} \leq T_{\text{amb}} \leq 60^{\circ}\text{C}$   
 Storage temperature  $-20 \dots 70^{\circ}\text{C}$   
 Protection class (housing) IP 65 acc. to DIN EN 60529



**Electrical Data**

Nominal supply voltage 24 V DC / AC  
 Operating supply voltage 12 ... 32 V DC / AC  
 Output signal 0 ... 20 mA, 4 ... 20 mA, 0 ... 10 V DC (3-wire)

Output signal load With output current  $R_L \leq (U_B - 4 \text{ V}) / 0.02 \text{ A}$  ( $U_B \leq 26\text{V}$ ), else  $R_L \leq 1100 \Omega$   
 With output voltage  $R_L \geq 2 \text{ K}\Omega$  ( $U_B \geq 15 \text{ V}$ ),  $R_L \geq 10 \text{ K}\Omega$  ( $U_B = 12 \dots 15\text{V}$ )

Power consumption Approx. 2 W / VA

Switching contacts 2 programmable voltage free MOSFET switch outputs; NO/NC  
 $U = 3 \dots 32 \text{ V DC/AC}$ ,  $I_{\text{max}} = 0.25 \text{ A}$ ,  $P_{\text{max}} = 8 \text{ W/VA}$ ,  $R_{\text{ON}} \leq 4 \Omega$

Display 3½ digit LED

#### Connections, Materials, Mounting

Electrical connections Two round-shell multi-pin connector sockets (M12, male)  
 Connector 1: 5-pin: power input and analogue signal output  
 Connector 2: 4-pin: solid-state switch outputs

Pressure connections Cutting ring fittings (aluminium) for 8/6 or 6/4 mm tubes

Materials, housing Polyamide PA 6,6

Materials, media contact Silicon, PVC, aluminum, brass

Mounting Rear mounting holes for panel mounting  
 Wall mountable using adaptor plate

Declaration per Directive 94/9/EC (ATEX)  II 3D IP65 T125°C



Power supply | Acc. to EN 50021  
 Quint 24V DC/5A/Ex EEx nAC IIC T4

## 11.2. Programming

Via membrane key-switches or by using PC-programming interface (accessory), programming mode can be password protected.

### Settings:

Input filtering	0.0 ... 100.0 secs (10 / 90% step response time) for signal output, display seperated
Display function	0.0 = Pressure port 1 only. 0.1 = Pressure port 2 only. 0.2 ... 25.5 = Display alternating time (0)
Relay / switch 1 / 2	Activation point, de-activation point, response time delay (0.0 ... 100.0 secs), logic (N/O or N/C)
Measurement unit selection	mbar / Pa / „free unit“ start value, end value and decimal place for „free unit“
Zero suppression	0 ... 100 counts (1)
Output signal start / end value	Can be set at any point of measuring range (2)
Zero pressure calibration - pressure port 1 / 2	±100 counts (3)
Output characteristic	Linear, square rooted, horizontal cylindr. tank, table (3...30 entries)
Password range	001 ... 999 (000 = password protection disabled)

(0) The display alternates between pressure ports 1 and 2 equally, each for the pre-set time

(1) Measured value deviations up to 100 counts, symmetric about zero, are set to zero. Used for zero drift suppression.

(2) Maximum effective turn-down ratio = 4:1. Only the output signal is affected. Transfer function is inverted if start value > end value.

(3) Zero calibration setting may change with mounting orientation.

Note: 1. Relay/switch output 1 and output signal are for pressure port 1.

2. Relay/switch output 2 is for pressure port 2.

## 12. Dimensions (all units in mm unless otherwise stated)

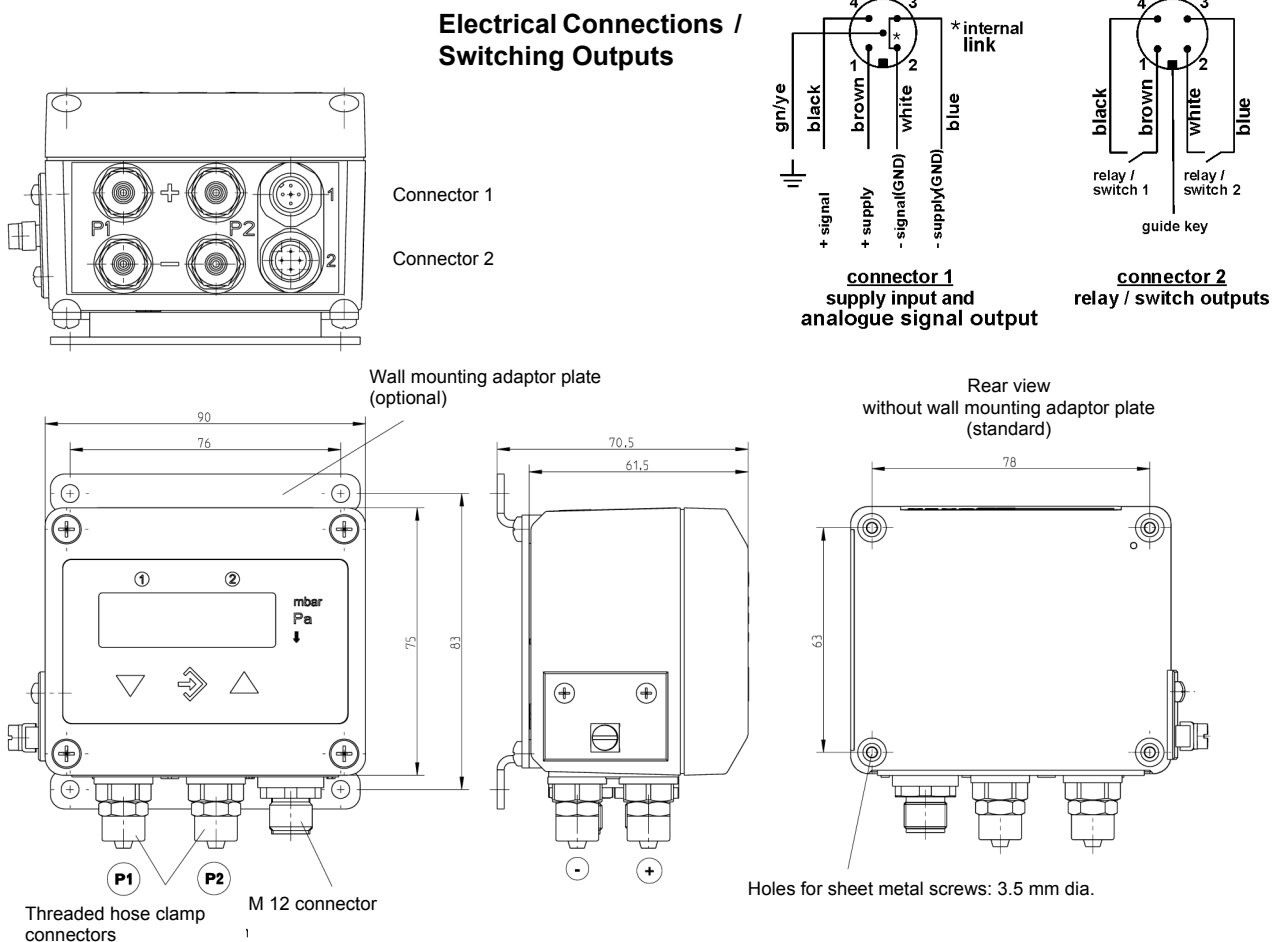

### 13. Ordering Code

#### Digital 2-Channel Differential Pressure Switch / Transmitter

DE44

									K	S			
--	--	--	--	--	--	--	--	--	---	---	--	--	--

**Pressure Port I  
Measuring Range**

**max. Static Operating Pressure**

0 ... 4 mbar	50 mbar	> 5	2
0 ... 6 mbar	50 mbar	> 5	3
0 ... 10 mbar	100 mbar	> 5	4
0 ... 16 mbar	100 mbar	> 5	5
0 ... 25 mbar	250 mbar	> 5	6
0 ... 40 mbar	250 mbar	> 5	7
0 ... 60 mbar	500 mbar	> 5	8
0 ... 100 mbar	500 mbar	> 5	9
- 2.5 ... 2.5 mbar	50 mbar	> A	6
- 4 ... 4 mbar	50 mbar	> A	7
- 6 ... 6 mbar	100 mbar	> A	8
- 10 ... 10 mbar	100 mbar	> A	9
- 16 ... 16 mbar	250 mbar	> B	1
- 25 ... 25 mbar	250 mbar	> B	2
- 40 ... 40 mbar	500 mbar	> C	5
- 60 ... 60 mbar	500 mbar	> B	3

**Pressure Port II  
Measuring Range**

**max. Static Operating Pressure**

0 ... 4 mbar	50 mbar	> 5	2
0 ... 6 mbar	50 mbar	> 5	3
0 ... 10 mbar	100 mbar	> 5	4
0 ... 16 mbar	100 mbar	> 5	5
0 ... 25 mbar	250 mbar	> 5	6
0 ... 40 mbar	250 mbar	> 5	7
0 ... 60 mbar	500 mbar	> 5	8
0 ... 100 mbar	500 mbar	> 5	9
- 2.5 ... 2.5 mbar	50 mbar	> A	6
- 4 ... 4 mbar	50 mbar	> A	7
- 6 ... 6 mbar	100 mbar	> A	8
- 10 ... 10 mbar	100 mbar	> A	9
- 16 ... 16 mbar	250 mbar	> B	1
- 25 ... 25 mbar	250 mbar	> B	2
- 40 ... 40 mbar	500 mbar	> C	5
- 60 ... 60 mbar	500 mbar	> B	3

**Pressure Connections**

Threaded hose clamp connectors for 6 / 4 mm hose	> 4	0
Threaded hose clamp connectors for 8 / 6 mm hose	> 4	1

**Signal Output (Pressure Port I only)**

No signal output	>	0
Current output: 0 - 20 mA linear, 3-wire	>	A
Voltage output: 0 - 10 V DC linear, 3-wire	>	C
Current output: 4 - 20 mA linear, 3-wire	>	P

**Supply Voltage**

24 V DC/AC nominal (12-32 V DC/AC operating)	>	K
--	---	---

**Customized Number**

This additon describes all customised features

Marking for usage in zone 22 - hazardous dust CE II 3 D IP65 T125°C	>	S
---	---	---

Display and Limit Switching Outputs	>	#
-------------------------------------	---	---

Transmitter without contacts  
3½ digit LED display; 2 solid-state switch outputs

Electrical Connection	>	#
-----------------------	---	---

M12 connection

Mounting	>	#
----------	---	---

Standard (rear mounting holes)  
Wallmounting

### 13.1. Accessories

Ordering Code	Designation	Pins	Application	Length
06401993	Cable with M12 connector	4-pin	for switch	2 m
06401994	Cable with M12 connector	4-pin	for switch	5 m
06401995	Cable with M12 connector	5-pin	for supply / signal	2 m
06401996	Cable with M12 connector	5-pin	for supply / signal	5 m
04005144	Wall mounting adaptor plate			
EU03.F300	PC-programming interface with SW			

### 14. Declaration of Conformity



<p><b>EG-Konformitätserklärung</b></p> <p>Wir erklären in alleiniger Verantwortung, dass nachstehend genannte Produkte</p> <p style="text-align: center;"><b>Fischer-Typen / Fischer-models</b>  <b>Datenblätter-Bedienungsanleitung / data sheets-operating instructions</b>  <b>Digitaler Zweikanal Differenzdruck- / Digital 2-Channel Differential Pressure</b>  <b>schalter/ -transmitter / Switch / Transmitter</b></p> <p style="text-align: center;"><b>DE44 ##### K S ###</b>  <b>DB_BA_D_DE44_S / DB_BA_GB_DE44_S</b></p> <p>gemäß gültigem Datenblatt übereinstimmen mit der</p> <table border="0" style="width: 100%;"> <tr> <td style="width: 50%;"><b>EG-Richtlinie</b></td> <td style="width: 50%;"><b>Explosionsschutz-Richtlinie</b></td> </tr> <tr> <td>2004/108/EG (EMV)</td> <td>94/9/EG</td> </tr> </table> <p>Ferner wurden sie dem Konformitätsbewertungsverfahren „Interne Fertigungskontrolle“ unterzogen.</p> <p>Die Produkte wurden entsprechend der folgenden Normen geprüft (Störfestigkeit für Industriebereich, Störaussendung für Wohnbereich):</p> <table border="0" style="width: 100%;"> <tr> <td style="width: 50%;">DIN EN 61326-1:2004-05 DIN EN 61326-2-3 DIN EN 61010-1:2002-08</td> <td style="width: 50%;">DIN EN 50281-1-1</td> </tr> </table> <p>Die Geräte werden gekennzeichnet mit:</p>	<b>EG-Richtlinie</b>	<b>Explosionsschutz-Richtlinie</b>	2004/108/EG (EMV)	94/9/EG	DIN EN 61326-1:2004-05 DIN EN 61326-2-3 DIN EN 61010-1:2002-08	DIN EN 50281-1-1	<p><b>EC Declaration of Conformity</b></p> <p>We declare under our sole responsibility that the products mentioned below</p> <p style="text-align: center;"><b>Fischer-Typen / Fischer-models</b>  <b>Datenblätter-Bedienungsanleitung / data sheets-operating instructions</b>  <b>Digital 2-Channel Differential Pressure</b>  <b>Switch / Transmitter</b></p> <p style="text-align: center;"><b>DE44 ##### K S ###</b>  <b>DB_BA_D_DE44_S / DB_BA_GB_DE44_S</b></p> <p>specified by the actual data sheet complies with the</p> <table border="0" style="width: 100%;"> <tr> <td style="width: 50%;"><b>EC Directive</b></td> <td style="width: 50%;"><b>Guideline for explosion protection</b></td> </tr> <tr> <td>2004/108/EC (EMC)</td> <td>94/9/EC</td> </tr> </table> <p>Also they were subjected to the conformity assessment procedure "Internal Control of Production".</p> <p>The instruments have been tested in compliance with the norms (Immunity for industrial environments, emission for residential environments):</p> <table border="0" style="width: 100%;"> <tr> <td style="width: 50%;">DIN EN 61326-1:2004-05 DIN EN 61326-2-3 DIN EN 61010-1:2002-08</td> <td style="width: 50%;">DIN EN 50281-1-1</td> </tr> </table> <p>The gauges are marked with:</p>	<b>EC Directive</b>	<b>Guideline for explosion protection</b>	2004/108/EC (EMC)	94/9/EC	DIN EN 61326-1:2004-05 DIN EN 61326-2-3 DIN EN 61010-1:2002-08	DIN EN 50281-1-1
<b>EG-Richtlinie</b>	<b>Explosionsschutz-Richtlinie</b>												
2004/108/EG (EMV)	94/9/EG												
DIN EN 61326-1:2004-05 DIN EN 61326-2-3 DIN EN 61010-1:2002-08	DIN EN 50281-1-1												
<b>EC Directive</b>	<b>Guideline for explosion protection</b>												
2004/108/EC (EMC)	94/9/EC												
DIN EN 61326-1:2004-05 DIN EN 61326-2-3 DIN EN 61010-1:2002-08	DIN EN 50281-1-1												



II 3 D IP65 T125°C

Bad Salzufen, 28.01.08  
(Ort, Datum / place, date)

  
 (rechtsverb. Unterschrift / authorized signature)

Fischer Mess- & Regeltechnik GmbH Bielefelder Strasse 37a D-32107 Bad Salzufen USt-IdNr.: DE124602659 Steuer-Nr.: 3135729/0559	Fon: +49 (0) 52 22-9740 Fax: +49 (0) 52 22-71 70 Web: www.fischermesstechnik.de Mail: info@fischermesstechnik.de	Sparkasse Lemgo BLZ 482 501 10 Konto-Nr.: 11 841 BIC: WELADED1LEM IBAN: DE90462501100000011841	Postbank Hannover BLZ 250 100 30 Konto-Nr.: 0201 830 307 BIC: PBNKDEFF IBAN: DE 98 2501 0030 0201 8303 07
--	---	--	---

Sitz/reg. office: Bad Salzufen  
Amtsgericht Lemgo HRB 226  
Geschäftsführer/ Manag. Dir.:  
Günter B. Gödde

Technische Änderungen vorbehalten • Subject to change without notice • Changements techniques sous réserve