

## Control valves with electric actuators up to 350°C

**PN 16-40 2.3.1**

Flanged connection PN 16 – 40 Cast iron Spheroidal graphite Cast steel Stainless steel	with electric actuators MC103/24 • MC103/230 MC163/24 • MC163/230 MC253/24 • MC253/230 MC403/24 • MC403/230 MC503/24 • MC503/230 MC1003/24 • MC1003/230 MC1503/24 • MC1503/230 M300-20kN • M300Y-20kN M300-25kN • M300Y-25kN
---	---

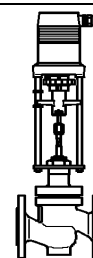

**BR216  
BR225  
BR240S  
BR240E**

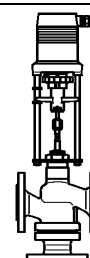

**BR316  
BR325  
BR340S  
BR340E**

### Features

- Suitable in building and process engineering for various mediums 0...+200°C
- Suitable with stuffing box extension or stem seal with stainless steel bellow to –10...+350°C and for valves made of stainless steel to –30...+350°C
- Suitable with stem heater for water with antifreeze compounds down to –10°C and for valves made of stainless steel to –30
- Microprocessor controlled
- Automatic self-calibration on start up

### Technical data valve

Series	BR216	BR225	BR240S	BR240E
Form	Two-way			
Diameter nominal	DN 125 – DN 300	DN 15 – DN 250 <sup>1)</sup>	DN 15 – DN 300	
Pressure rating	PN 16	PN 16 / PN 25 / PN 40	PN 40	
Body	Cast iron EN-JL1040	Spheroidal graphite EN-JS1024	Cast steel 1.0619+N	Stainless steel 1.4408
Plug	CrNi-steel 1.4057			CrNi-steel 1.4571
Stem	CrMo-steel 1.4122			CrNi-steel 1.4571
Characteristic	≤ DN 50: equal % ≥ DN 65: eq. % mod. Perforated plug: equal %		Option: linear Option: linear Option: linear	
Stroke [mm] MC103 – MC1503	20 (DN 15 – DN 40) 30 (DN 50 – DN 65) 50 (DN 80 – DN 100) 60 (DN 125 – DN 200) 80 (DN 250 – DN 300)			
Stroke [mm] M300(Y)	60 (DN 125 – DN 150)		25 kN	
	80 (DN 200)		20 kN / 25 kN	
	90 (DN 250 – DN 300)		20 kN / 25 kN	
Rangeability	≥ 50:1			
Connection type	Flanges acc. EN 1092-2 Typ 21		Flanges acc. EN 1092-1 Typ 21	
Pressure, Temp.	Acc. EN 1092 part 2		Acc. EN 1092 part 1	

<sup>1)</sup> DN 150: PN 16 or PN 25  
DN 200: PN 16

## Control valves with electric actuators up to 350°C

**PN 16-40 2.3.1**

Flanged connection PN 16 – 40 Cast iron Spheroidal graphite Cast steel Stainless steel	with electric actuators MC103/24 • MC103/230 MC163/24 • MC163/230 MC253/24 • MC253/230 MC403/24 • MC403/230 MC503/24 • MC503/230 MC1003/24 • MC1003/230 MC1503/24 • MC1503/230 M300-20kN • M300Y-20kN M300-25kN • M300Y-25kN
---	---

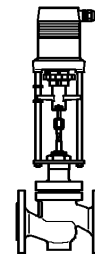

**BR216  
BR225  
BR240S  
BR240E**

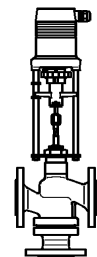

**BR316  
BR325  
BR340S  
BR340E**

Series	BR316	BR325	BR340S	BR340E
Form	Three-way			
Diameter nominal	DN 125 – DN 300	DN 15 – DN 250 <sup>1)</sup>	DN 15 – DN 300	
Pressure rating	PN 16	PN 25	PN 40	
Body	Cast iron <sup>2)</sup> EN-JL1040	Spheroidal graphite EN-JS1024	Cast steel 1.0619+N	Stainless steel 1.4408
Plug	CrNi-steel 1.4057			CrNi-steel 1.4571
Stem	CrMo-steel 1.4122			CrNi-steel 1.4571
Characteristic	≤ DN 40: A→AB equal %    Option: linear B→AB linear ≥ DN 50: A→AB eq. % mod. Option: linear B→AB linear			
Stroke [mm] MC103 – MC1503	20 (DN 15 – DN 40) 30 (DN 50 – DN 65) 50 (DN 80 – DN 100) 60 (DN 125 – DN 200) 80 (DN 250 – DN 300)			
Stroke [mm] M300(Y)	60 (DN 125 – DN 150)		25 kN	
	80 (DN 200)		20 kN / 25 kN	
	90 (DN 250 – DN 300)		20 kN / 25 kN	
Rangeability	≥ 50:1			
Connection type	Flanges acc. EN 1092-2 Typ 21		Flanges acc. EN 1092-1 Typ 21	
Pressure, Temp.	Acc. EN 1092 part 2		Acc. EN 1092 part 1	

Function: BR216/225/240S/240E as two-way valve  
 BR316/325/340S/340E as mixing valve or  
 BR316/325/340S/340E as diverting valve with reduced closing pressure

Face to face dimension: Acc. EN 558-1 basic series 1

Leakage rate: EN 1349 – seat-leakage IV L1 (≤ 0.01% of kvs-value)

Stem sealing: O-rings made of EPDM    0...+180°C    chilled and hot-water with max. 50% antifreeze and anti-corrosive compounds: glycol, ethylene glycol, mono ethylene, ethanol, methyl alcohol, glycerine, antifrogen® N+L

O-rings made of FKM    0...+200°C    media based on mineral oil

O-rings made of Fluoraz®    0...+200°C    hot water, steam and oil

PTFE-lip-rings    0...+200°C    hot water, steam and oil

Graphite-Packing    0...+350°C <sup>3)</sup>    hot water, steam and oil

<sup>1)</sup> DN 150: PN 16 or PN 25  
 DN 200: PN 16

<sup>2)</sup> Due to a change in material, we reserve the right to supply valves up to DN 100 in higher grade spheroidal graphite EN-JS1024

<sup>3)</sup> only in combination with stuffing box extension or stem seal with stainless steel bellow

## Control valves with electric actuators up to 350°C

**PN 16-40 2.3.1**

Flanged connection PN 16 – 40 Cast iron Spheroidal graphite Cast steel Stainless steel	with electric actuators MC103/24 • MC103/230 MC163/24 • MC163/230 MC253/24 • MC253/230 MC403/24 • MC403/230 MC503/24 • MC503/230 MC1003/24 • MC1003/230 MC1503/24 • MC1503/230 M300-20kN • M300Y-20kN M300-25kN • M300Y-25kN
---	---

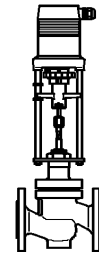

**BR216  
BR225  
BR240S  
BR240E**

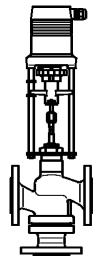

**BR316  
BR325  
BR340S  
BR340E**

### Valve variant and accessories

for two-way and three-way valves:

- Housing connecting flanges: with groove acc. to EN 1092-1 type D,  
with socket acc. to EN 1092-1 type F,  
with spigot acc. to EN 1092-1 type E
- Body and plug seat grounded in, EN 1349 – seat-leakage IV-S1 L1 ( $\leq 0.0005\%$  of kvs-value)
- Plug with soft sealing made of NBR, EPDM, PTFE; EN 1349 – seat-leakage VI G1 (tight sealing)
- Stem heater: 24 VAC, 50 Hz or 24 VDC  
 $P_{max.} \approx 200 \text{ VA}$   
 $P_N \approx 45 \text{ VA}$   
 S1 100% ED  
 IP 54
- Transformer for stem heater: 230/24 VAC, 50 Hz
- Stem seal with stainless steel bellow: for valves made of cast iron –10°C...+200°C  
 for valves made of spheroidal graphite  
 and cast steel –10°C...+350°C  
Stuffing box made of graphite  
 for valves made of stainless steel –30°C...+350°C  
Stuffing box made of graphite
- Stuffing box extension: 100 mm  
 for valves made of spheroidal graphite  
 and cast steel –10°C...+350°C  
 for valves made of stainless steel –30°C...+350°C
- Epoxy resin special varnish as a corrosion resistant in case of condensed water, max. 80°C<sup>1)</sup>
- technical silicon free version, max. 180°C
- oil and fat free for oxygen application

only for two-way valves:

- Screwed seat: for valves made of cast iron, spheroidal graphite and cast steel made of 1.4122,  
unhardened or hardened  
for valves made of stainless steel made of 1.4571
- Perforated plug: for valves made of cast iron, spheroidal graphite and cast steel made of 1.4057,  
unhardened or hardened  
for valves made of stainless steel made of 1.4571
- Housing seat SKWAM plated or Stellite 6 plated<sup>2)</sup>
- Balanced plug, max. operating temperature 200°C

<sup>1)</sup> except valves made of stainless steel

<sup>2)</sup> only for valves made of spheroidal graphite and stainless steel

## Control valves with electric actuators up to 350°C

**PN 16-40 2.3.1**

Flanged connection PN 16 – 40 Cast iron Spheroidal graphite Cast steel Stainless steel	with electric actuators MC103/24 • MC103/230 MC163/24 • MC163/230 MC253/24 • MC253/230 MC403/24 • MC403/230 MC503/24 • MC503/230 MC1003/24 • MC1003/230 MC1503/24 • MC1503/230 M300-20kN • M300Y-20kN M300-25kN • M300Y-25kN
---	---

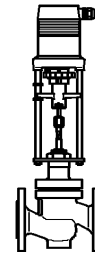

**BR216  
BR225  
BR240S  
BR240E**

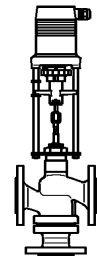

**BR316  
BR325  
BR340S  
BR340E**

### Drawing

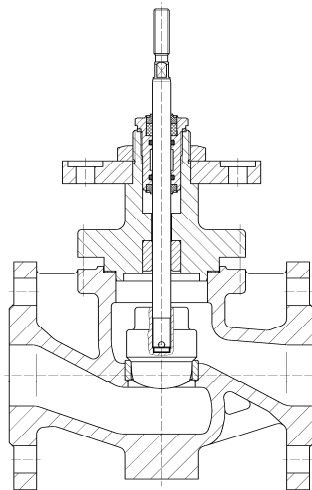

BR216/225/240S/240E

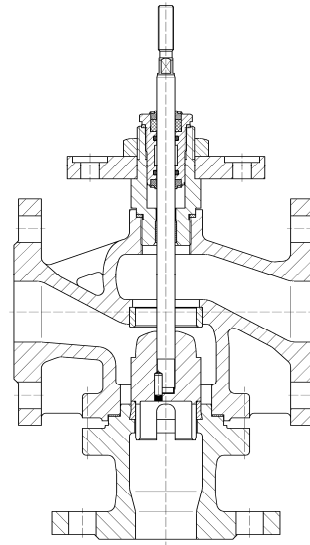

BR316/325/340S/340E

### Technical data actuator MC103 – MC1503

Type		MC103/24 <sup>5)</sup>	MC103/230 <sup>5)</sup>
Actuating time <sup>1)</sup>	s/mm	12 · 9 · 4* · 1.9	12 · 9 · 4* · 1.9
Actuating thrust	kN	1.0	1.0
Stroke	mm	max. 20	max. 20
Power supply	VAC	24 ±10%	230 +6% -10%
Power supply <sup>2)</sup>	VDC	24 ±10%	-
Frequency	Hz	50/60 ±5%	50/60 ±5%
Power consumption	VA	6	12
Input signal <sup>3)</sup>		3-point 0(2)...10 VDC 77 kOhm 0(4)...20 mA 0.51 kOhm	3-point 0(2)...10 VDC 77 kOhm 0(4)...20 mA 0.51 kOhm
Output signal <sup>3)</sup>		0...10 VDC max. 8 mA min. 1200 Ohm	0...10 VDC max. 8 mA min. 1200 Ohm
Hysteresis <sup>4)</sup>	V	0.15 · 0.5	0.15 · 0.5

<sup>1)</sup> Actuating time freely adjustable, presetting is marked with \*

<sup>2)</sup> only rectified alternating voltage

<sup>3)</sup> Invertible input and output signal

<sup>4)</sup> Freely adjustable

<sup>5)</sup> Actuator suitable for medium temperature up to 150°C

## Control valves with electric actuators up to 350°C

## PN 16-40 2.3.1

Flanged connection PN 16 – 40 Cast iron Spheroidal graphite Cast steel Stainless steel	with electric actuators MC103/24 • MC103/230 MC163/24 • MC163/230 MC253/24 • MC253/230 MC403/24 • MC403/230 MC503/24 • MC503/230 MC1003/24 • MC1003/230 MC1503/24 • MC1503/230 M300-20kN • M300Y-20kN M300-25kN • M300Y-25kN
---	---

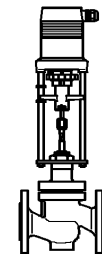

**BR216  
BR225  
BR240S  
BR240E**

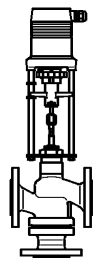

**BR316  
BR325  
BR340S  
BR340E**

Type		MC163/24	MC163/230
Actuating time <sup>1)</sup>	s/mm	6 · 4*	6 · 4*
Actuating thrust	kN	1.6	1.6
Stroke	mm	max. 30	max. 30
Power supply	VAC	24 ±10%	230 +6% -10%
Power supply <sup>2)</sup>	VDC	24 ±10%	-
Frequency	Hz	50/60 ±5%	50/60 ±5%
Power consumption	VA	6	12
Input signal <sup>3)</sup>		3-point 0(2)...10 VDC    77 kOhm 0(4)...20 mA    0.51 kOhm	3-point 0(2)...10 VDC    77 kOhm 0(4)...20 mA    0.51 kOhm
Output signal <sup>3)</sup>		0...10 VDC    max. 8 mA min. 1200 Ohm	0...10 VDC    max. 8 mA min. 1200 Ohm
Hysteresis <sup>4)</sup>	V	0.05 · 0.15 · 0.3 · 0.5	0.05 · 0.15 · 0.3 · 0.5

Type		MC253/24	MC253/230
Actuating time <sup>1)</sup>	s/mm	5 · 2.5*	5 · 2.5*
Actuating thrust	kN	2.5	2.5
Stroke	mm	max. 60	max. 60
Power supply	VAC	24 ±10%	230 +6% -10%
Power supply <sup>2)</sup>	VDC	24 ±10%	-
Frequency	Hz	50/60 ±5%	50/60 ±5%
Power consumption	VA	max. 18	max. 25
Input signal <sup>3)</sup>		3-point 0(2)...10 VDC    77 kOhm 0(4)...20 mA    0.51 kOhm	3-point 0(2)...10 VDC    77 kOhm 0(4)...20 mA    0.51 kOhm
Output signal <sup>3)</sup>		0...10 VDC    max. 8 mA min. 1200 Ohm	0...10 VDC    max. 8 mA min. 1200 Ohm
Hysteresis <sup>4)</sup>	V	0.05 · 0.15 · 0.3 · 0.5	0.05 · 0.15 · 0.3 · 0.5

<sup>1)</sup> Actuating time freely adjustable, presetting is marked with \*

<sup>2)</sup> only rectified alternating voltage

<sup>3)</sup> Invertible input and output signal

<sup>4)</sup> Freely adjustable

## Control valves with electric actuators up to 350°C

**PN 16-40 2.3.1**

Flanged connection	with electric actuators
PN 16 – 40	MC103/24 • MC103/230
Cast iron	MC163/24 • MC163/230
Spheroidal graphite	MC253/24 • MC253/230
Cast steel	MC403/24 • MC403/230
Stainless steel	MC503/24 • MC503/230
	MC1003/24 • MC1003/230
	MC1503/24 • MC1503/230
	M300-20kN • M300Y-20kN
	M300-25kN • M300Y-25kN

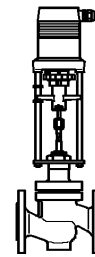

**BR216  
BR225  
BR240S  
BR240E**

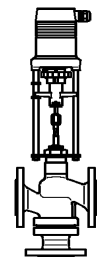

**BR316  
BR325  
BR340S  
BR340E**

Type		MC403/24	MC403/230
Actuating time <sup>1)</sup>	s/mm	0.6 · 0.4*	0.6 · 0.4*
Actuating thrust	kN	4.0	4.0
Stroke	mm	max. 60	max. 60
Power supply	VAC	24 ±10%	230 +6% -10%
Frequency	Hz	50/60 ±5%	50/60 ±5%
Power consumption	VA	max. 50	max. 63
Input signal <sup>3)</sup>		3-point 0(2)...10 VDC 77 kOhm 0(4)...20 mA 0.51 kOhm	3-point 0(2)...10 VDC 77 kOhm 0(4)...20 mA 0.51 kOhm
Output signal <sup>3)</sup>		0...10 VDC max. 8 mA min. 1200 Ohm	0...10 VDC max. 8 mA min. 1200 Ohm
Hysteresis <sup>4)</sup>	V	0.05 · 0.15 · 0.3 · 0.5	0.05 · 0.15 · 0.3 · 0.5

Type		MC503/24	MC503/230
Actuating time <sup>1)</sup>	s/mm	5 · 2.5*	5 · 2.*
Actuating thrust	kN	5.0	5.0
Stroke	mm	max. 60	max. 60
Power supply	VAC	24 ±10%	230 +6% -10%
Power supply <sup>2)</sup>	VDC	24 ±10%	-
Frequency	Hz	50/60 ±5%	50/60 ±5%
Power consumption	VA	max. 18	max. 25
Input signal <sup>3)</sup>		3-point 0(2)...10 VDC 77 kOhm 0(4)...20 mA 0.51 kOhm	3-point 0(2)...10 VDC 77 kOhm 0(4)...20 mA 0.51 kOhm
Output signal <sup>3)</sup>		0...10 VDC max. 8 mA min. 1200 Ohm	0...10 VDC max. 8 mA min. 1200 Ohm
Hysteresis <sup>4)</sup>	V	0.05 · 0.15 · 0.3 · 0.5	0.05 · 0.15 · 0.3 · 0.5

<sup>1)</sup> Actuating time freely adjustable, presetting is marked with \*

<sup>2)</sup> only rectified alternating voltage

<sup>3)</sup> Invertible input and output signal

<sup>4)</sup> Freely adjustable

## Control valves with electric actuators up to 350°C

**PN 16-40 2.3.1**

Flanged connection  
PN 16 – 40  
Cast iron  
Spheroidal graphite  
Cast steel  
Stainless steel

with electric actuators  
MC103/24 • MC103/230  
MC163/24 • MC163/230  
MC253/24 • MC253/230  
MC403/24 • MC403/230  
MC503/24 • MC503/230  
MC1003/24 • MC1003/230  
MC1503/24 • MC1503/230  
M300-20kN • M300Y-20kN  
M300-25kN • M300Y-25kN

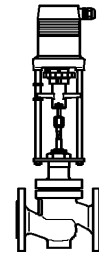

**BR216  
BR225  
BR240S  
BR240E**

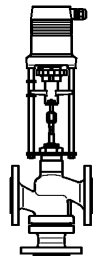

**BR316  
BR325  
BR340S  
BR340E**

Type		MC1003/24	MC1503/24	MC1003/230	MC1503/230
Actuating time <sup>1)</sup>	s/mm	1	2	1	2
Actuating thrust	kN	10	15	10	15
Stroke	mm	max. 80		max. 80	
Power supply	VAC	24 ±10%		230 +6% -10%	
Frequency	Hz	50/60 ±5%		50/60 ±5%	
Power consumption	VA	max. 50		max. 63	
Input signal <sup>2)</sup>		3-point 0(2)...10 VDC 77 kOhm 0(4)...20 mA 0.51 kOhm		3-point 0(2)...10 VDC 77 kOhm 0(4)...20 mA 0.51 kOhm	
Output signal <sup>2)</sup>		0...10 VDC max. 8 mA min. 1200 Ohm		0...10 VDC max. 8 mA min. 1200 Ohm	
Hysteresis <sup>3)</sup>	V	0.05 · 0.15 · 0.3 · 0.5		0.05 · 0.15 · 0.3 · 0.5	

Enclosure protection: IP 54

Resolution:

MC...	electric	0.04 VDC
MC103	mechanical	0.095 mm
MC163 / MC1003 / MC1503	mechanical	0.05 mm
MC253 / MC503	mechanical	0.04 mm
MC403	mechanical	0.12 mm

Operating mode:

MC103 / MC163 / MC253 / MC503	S3-50% ED c/h 1200	EN 60034-1
MC403 / MC1003 / MC1503	S3-30% ED c/h 1200	EN 60034-1

End position switch-off: load-dependent

Ambient temperature:

MC103 / MC163	0...+60°C
MC253 / MC403 / MC503 / MC1003	-10...+60°C
MC1503	-10...+50°C

Weight:

MC103	2.5 kg
MC163	4.0 kg
MC253/24 and MC503/24	7.4 kg
MC253/230 and MC503/230	8.6 kg
MC403	9.5 kg
MC1003 / MC1503	11.5 kg

<sup>1)</sup> Actuating time freely adjustable, presetting is marked with \*

<sup>2)</sup> Invertible input and output signal

<sup>3)</sup> Freely adjustable

## Control valves with electric actuators up to 350°C

PN 16-40 **2.3.1**

Flanged connection	with electric actuators
PN 16 – 40	MC103/24 • MC103/230
Cast iron	MC163/24 • MC163/230
Spheroidal graphite	MC253/24 • MC253/230
Cast steel	MC403/24 • MC403/230
Stainless steel	MC503/24 • MC503/230
	MC1003/24 • MC1003/230
	MC1503/24 • MC1503/230
	M300-20kN • M300Y-20kN
	M300-25kN • M300Y-25kN

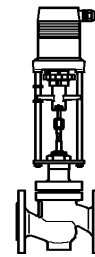

**BR216  
BR225  
BR240S  
BR240E**

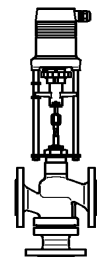

**BR316  
BR325  
BR340S  
BR340E**

### Actuator variant and accessories

- Voltage: 115 VAC
- Position switch unit <sup>1)</sup>: 2 switches (WE1/WE2), potential free, infinitely adjustable  
 Rated load: 8 A / 250 VAC  
                   8 A / 30 VDC  
 Turn-on voltage: max. 400 VAC  
                       max. 125 VDC
- Enclosure protection: IP 65
- Board for output signal X=0(4)...20 mA <sup>1)</sup>
- Adapter with coupling for external products

### Circuit diagram MC103 / MC163

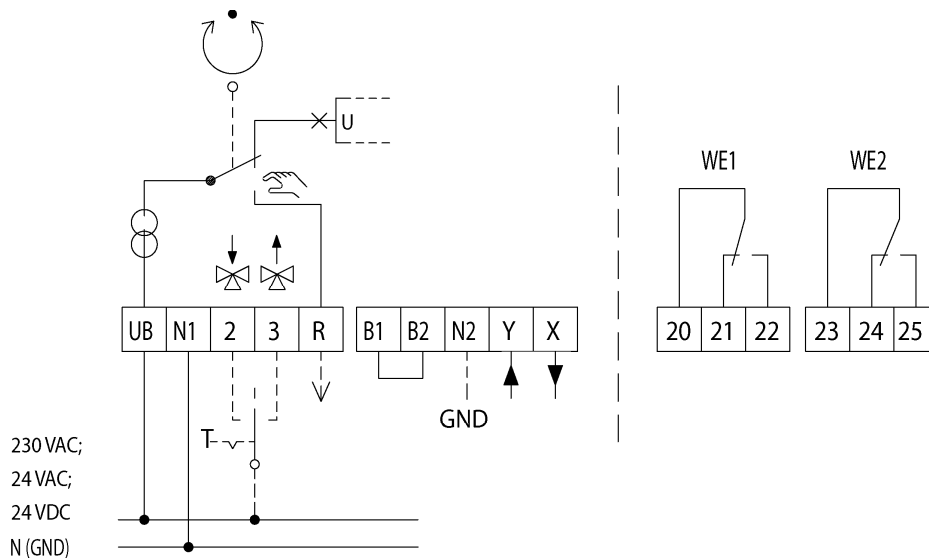

B1/B2 Connection of a binary signal (e.g. frost safety)

<sup>1)</sup> MC103/MC163: Position switch unit and output signal 0(4)...20 mA not in combination



## Control valves with electric actuators up to 350°C

**PN 16-40 2.3.1**

Flanged connection  
PN 16 – 40  
Cast iron  
Spheroidal graphite  
Cast steel  
Stainless steel

with electric actuators  
MC103/24 • MC103/230  
MC163/24 • MC163/230  
MC253/24 • MC253/230  
MC403/24 • MC403/230  
MC503/24 • MC503/230  
MC1003/24 • MC1003/230  
MC1503/24 • MC1503/230  
M300-20kN • M300Y-20kN  
M300-25kN • M300Y-25kN

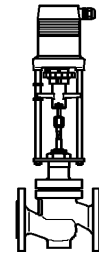

**BR216  
BR225  
BR240S  
BR240E**

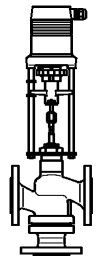

**BR316  
BR325  
BR340S  
BR340E**

### Circuit diagram MC253 / MC403 / MC503 / MC1003 / MC1503

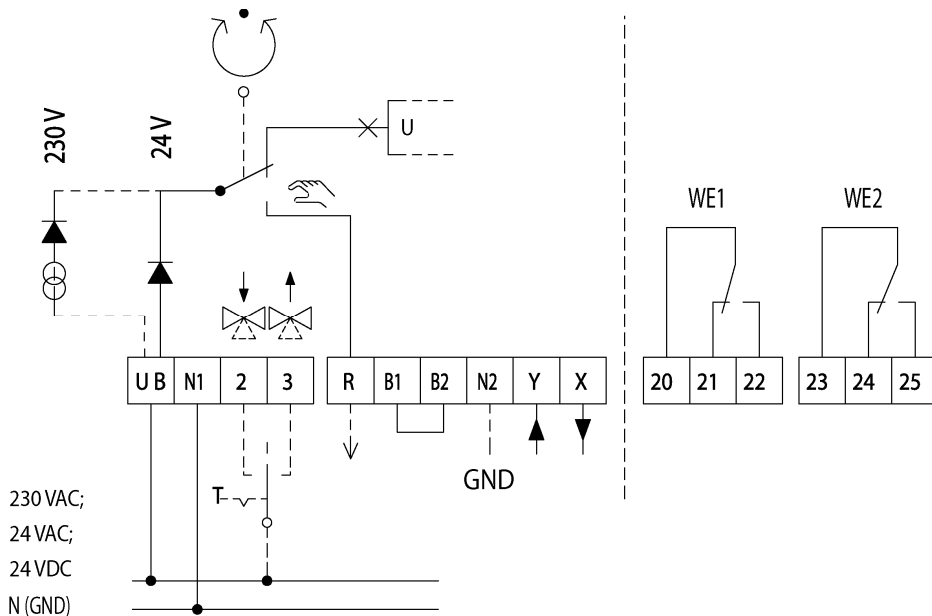

### Technical data actuator M300(Y)

Type		M300 – 20 kN		M300Y – 20 kN	
Actuating time at 50 Hz <sup>1)</sup>	s/mm	1.2	2.4	1.2	2.4
Actuating thrust	kN	20		20	
Stroke	mm	max. 90		max. 90	
Power supply	VAC	230 ±10%		230 ±10%	
Frequency	Hz	50 or 60 ±5%		50 or 60 ±5%	
Power consumption	VA	240	170	260	190
Input signal <sup>2)</sup>		3-point			
Output signal		-			
		0(2)...10 VDC 10 kOhm		0(4)...20 mA <sup>1)</sup> 500 Ohm	
		0(2)...10 VDC max. 20 mA		min. 500 Ohm	
		0(4)...20 mA <sup>1)</sup>		max. 500 Ohm	

<sup>1)</sup> Please state when ordering

<sup>2)</sup> Invertible input signal

## Control valves with electric actuators up to 350°C

PN 16-40 **2.3.1**

Flanged connection PN 16 – 40 Cast iron Spheroidal graphite Cast steel Stainless steel	with electric actuators MC103/24 • MC103/230 MC163/24 • MC163/230 MC253/24 • MC253/230 MC403/24 • MC403/230 MC503/24 • MC503/230 MC1003/24 • MC1003/230 MC1503/24 • MC1503/230 M300-20kN • M300Y-20kN M300-25kN • M300Y-25kN
---	---

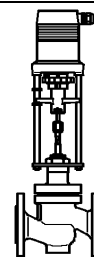

BR216  
BR225  
BR240S  
BR240E

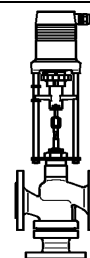

BR316  
BR325  
BR340S  
BR340E

Type		M300 – 25 kN		M300Y – 25 kN	
		1.2	2.4	1.2	2.4
Actuating time at 50 Hz <sup>1)</sup>	s/mm	1.2	2.4	1.2	2.4
Actuating thrust	kN	25		25	
Stroke	mm	max. 90		max. 90	
Power supply	VAC	230 ±10%		230 ±10%	
Frequency	Hz	50 or 60 ±5%		50 or 60 ±5%	
Power consumption	VA	240	170	260	190
Input signal <sup>2)</sup>		3-point		0(2)...10 VDC 10 kOhm 0(4)...20 mA <sup>1)</sup> 500 Ohm	
Output signal		-		0(2)...10 VDC max. 20 mA 0(4)...20 mA <sup>1)</sup> min. 500 Ohm max. 500 Ohm	

Enclosure protection:	IP 65
Limit switches (motor):	max. rated load: resistive load: 10 A inductive load: 5 A
Operating mode:	S4-30% ED c/h 600 EN 60034-1
End position switch-off:	Two-way valves: Extending actuator spindle: load-dependent Retracting actuator spindle: travel (WE-S3) and load-depend. Three-way valves: Extending and retracting actuator spindle: load-dependent
Ambient temperature:	0...+60°C
Weight:	22 kg

### Actuator variant and accessories

Type	M300 20 kN	M300 25 kN	M300Y 20 kN	M300Y 25 kN
Potentiometer (max. 2 pieces) 0,1 / 0,2 / 0,5 / 1 / 5 / 10 kOhm 1,5 VA	•	•		
Position switch unit 2 switches (WE-S4/WE-S5), max. 250 VAC potential free, infinitely adjustable max. rated load: resistive load 5 A inductive load 3 A filament lamp 1 A	•	•	•	•
Heater -20°C ... +60°C 230 VAC, 15 VA	•	•	•	•
Electric position indication Voltage: 24 VDC Output signal: X=0(4)...20 mA max. 500 Ohm	•	•		

<sup>1)</sup> Please state when ordering

<sup>2)</sup> Invertible input signal

## Control valves with electric actuators up to 350°C

PN 16-40 **2.3.1**

Flanged connection  
PN 16 – 40  
Cast iron  
Spheroidal graphite  
Cast steel  
Stainless steel

with electric actuators  
MC103/24 • MC103/230  
MC163/24 • MC163/230  
MC253/24 • MC253/230  
MC403/24 • MC403/230  
MC503/24 • MC503/230  
MC1003/24 • MC1003/230  
MC1503/24 • MC1503/230  
M300-20kN • M300Y-20kN  
M300-25kN • M300Y-25kN

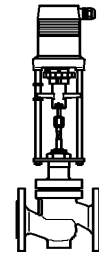

BR216  
BR225  
BR240S  
BR240E

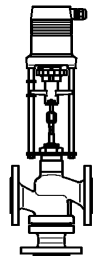

BR316  
BR325  
BR340S  
BR340E

### Circuit diagram M300 - 20 kN / M300 - 25 kN Two-way valves

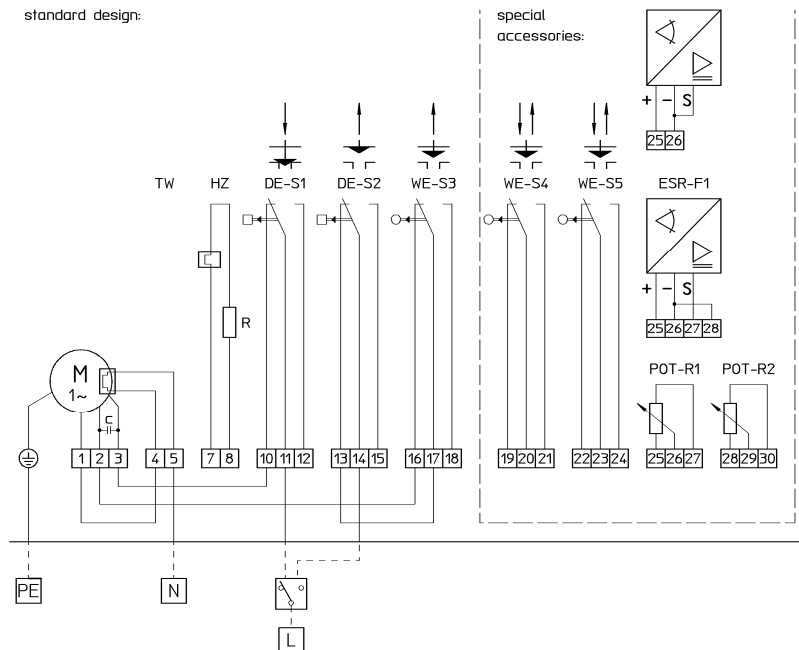

### Three-way valves

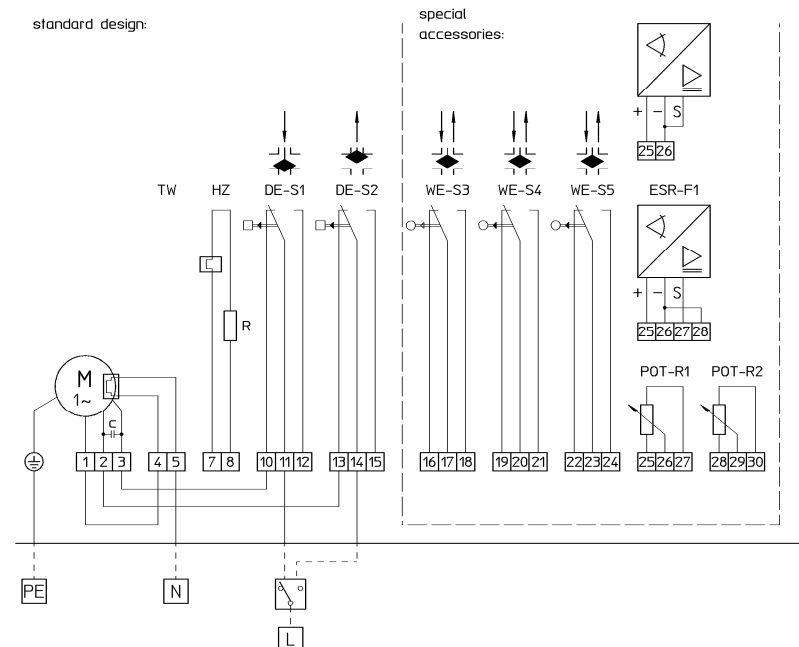

## Control valves with electric actuators up to 350°C

PN 16-40 **2.3.1**

Flanged connection  
PN 16 – 40  
Cast iron  
Spheroidal graphite  
Cast steel  
Stainless steel

with electric actuators  
MC103/24 • MC103/230  
MC163/24 • MC163/230  
MC253/24 • MC253/230  
MC403/24 • MC403/230  
MC503/24 • MC503/230  
MC1003/24 • MC1003/230  
MC1503/24 • MC1503/230  
M300-20kN • M300Y-20kN  
M300-25kN • M300Y-25kN

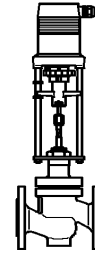

**BR216  
BR225  
BR240S  
BR240E**

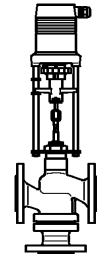

**BR316  
BR325  
BR340S  
BR340E**

### Circuit diagram M300Y - 20 kN / M300Y - 25 kN Two-way valves

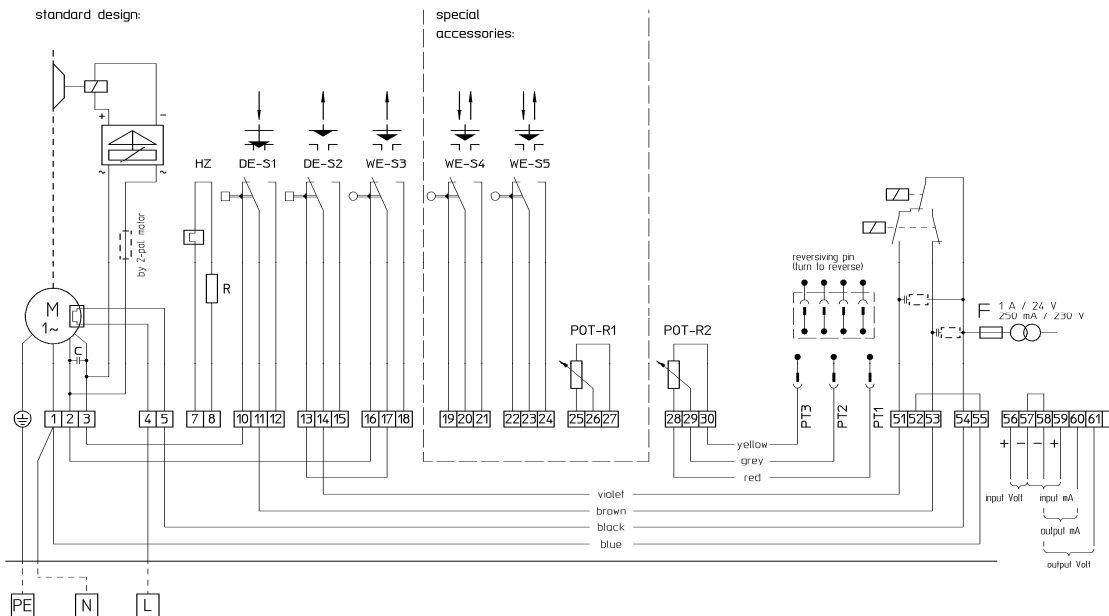

### Three-way valves

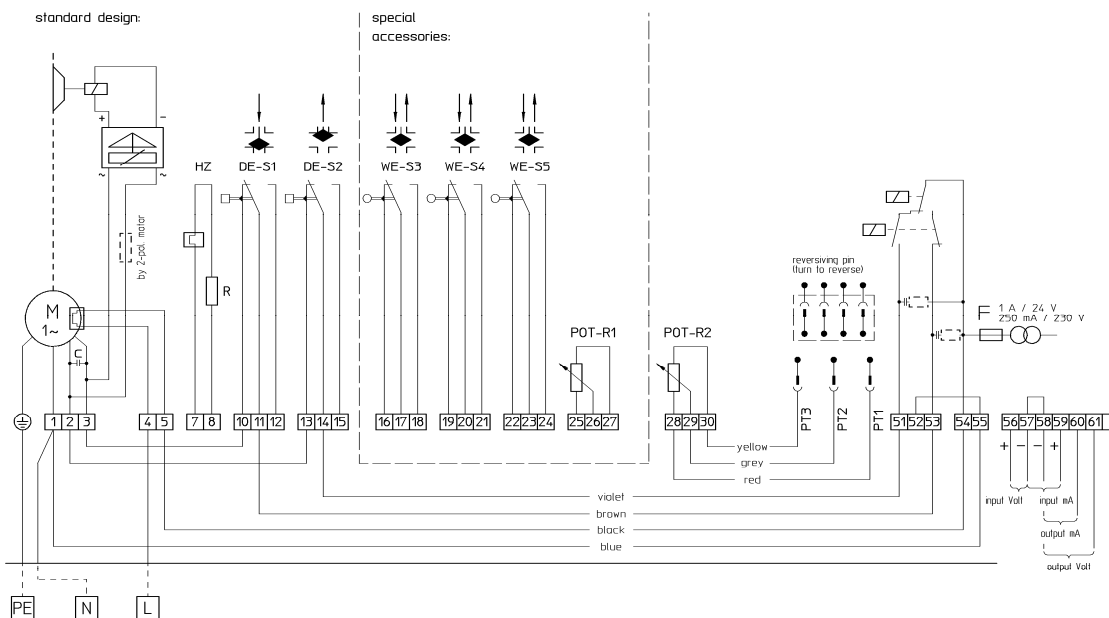

## Control valves with electric actuators up to 350°C

**PN 16-40 2.3.1**

Flanged connection PN 16 – 40 Cast iron Spheroidal graphite Cast steel Stainless steel	with electric actuators MC103/24 • MC103/230 MC163/24 • MC163/230 MC253/24 • MC253/230 MC403/24 • MC403/230 MC503/24 • MC503/230 MC1003/24 • MC1003/230 MC1503/24 • MC1503/230 M300-20kN • M300Y-20kN M300-25kN • M300Y-25kN
---	---

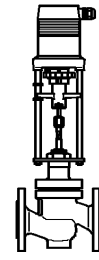

**BR216  
BR225  
BR240S  
BR240E**

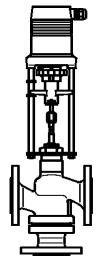

**BR316  
BR325  
BR340S  
BR340E**

### Technical data valve with actuator

#### PN 16 BR216

DN	125		150		200		250		300												
kvs-value	m <sup>3</sup> /h	250	400	630	1000	1250	200 <sup>S</sup>	160	125 <sup>S/L</sup>	250 <sup>S</sup>	315 <sup>S</sup>	500 <sup>S</sup>	630	800	1000	800	630 <sup>L</sup>	400 <sup>L</sup>	500 <sup>L</sup>	630 <sup>L</sup>	
		Stroke	60		80																
		MC403/24	t <sup>1)</sup>	40		25*															
				MC403/230	Δp <sub>s</sub>	kPa															200
MC503/24	t <sup>1)</sup>	300					150*														
		MC503/230	Δp <sub>s</sub>	kPa	290	190															
MC1003/24	t				60		80														
		MC1003/230	Δp <sub>s</sub>	kPa	500	350	200	100													
MC1503/24	t				120		160														
		MC1503/230	Δp <sub>s</sub>	kPa	950	700	370	220	150												

DN	125		150		200		250		300										
kvs-value	m <sup>3</sup> /h	250	400	630	1000	1600	200 <sup>S</sup>	160	125 <sup>S/L</sup>	250 <sup>S</sup>	315 <sup>S</sup>	500 <sup>S</sup>	630 <sup>L</sup>	800	1000	800 <sup>L</sup>			
		Stroke	60		80												90		
		M300/M300Y 20 kN	t <sup>2)</sup>	155		205											225		
				Δp <sub>s</sub>	kPa	1400											980	540	340
M300/M300Y 25 kN	t <sup>2)</sup>	155				205		225											
		Δp <sub>s</sub>	kPa	1600	1250	690	440	300											

100 kPa = 1 bar = 10 mWS

Δp<sub>s</sub>: Closing pressure

<sup>1)</sup> Actuating time freely adjustable, presetting is marked with \*

<sup>2)</sup> Please state when ordering

<sup>L)</sup> Available with perforated plug

<sup>S)</sup> Special-kvs-value

## Control valves with electric actuators up to 350°C

**PN 16-40 2.3.1**

Flanged connection  
PN 16 – 40  
Cast iron  
Spheroidal graphite  
Cast steel  
Stainless steel

with electric actuators  
MC103/24 • MC103/230  
MC163/24 • MC163/230  
MC253/24 • MC253/230  
MC403/24 • MC403/230  
MC503/24 • MC503/230  
MC1003/24 • MC1003/230  
MC1503/24 • MC1503/230  
M300-20kN • M300Y-20kN  
M300-25kN • M300Y-25kN

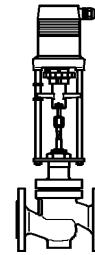

**BR216  
BR225  
BR240S  
BR240E**

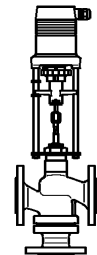

**BR316  
BR325  
BR340S  
BR340E**

### PN 16 BR316

DN			125	150	200	250	300	
kvs-value	m <sup>3</sup> /h		250	400	630	1000	1250	
			200	315	500	800	1000	
			160 <sup>S</sup>	250 <sup>S</sup>	400 <sup>S</sup>	630	800	
			125 <sup>S</sup>	200 <sup>S</sup>	315 <sup>S</sup>	500	630	
Stroke			60			80		
MC403/ 24	t <sup>1)</sup>	s	40					
			25*					
MC403/ 230	Δp <sub>s</sub>	kPa	200	130				
			300					
MC503/ 24	t <sup>1)</sup>	s	300					
			150*					
MC503/ 230	Δp <sub>s</sub>	kPa	290	190				
			MC1003/ 24	t	s	60		
MC1003/ 230	Δp <sub>s</sub>	kPa				500	350	200
			MC1503/ 24	t	s	120		
MC1503/ 230	Δp <sub>s</sub>	kPa				950	700	370

### PN 16 BR316

DN			125	150	200	250	300
kvs-value	m <sup>3</sup> /h		250	400	630	1000	1600
			200	315	500	800	1250
			160 <sup>S</sup>	250 <sup>S</sup>	400 <sup>S</sup>	630	1000
			125 <sup>S</sup>	200 <sup>S</sup>	315 <sup>S</sup>	500	800
Stroke			60		80	90	
M300/ M300Y 20 kN	t <sup>1)</sup>	s	155			205	225
			80			105	120
M300/ M300Y 25 kN	Δp <sub>s</sub>	kPa	1400	980	540	340	240
			M300/ M300Y 25 kN	t <sup>1)</sup>	s	155	
M300/ M300Y 25 kN	Δp <sub>s</sub>	kPa				80	
			M300/ M300Y 25 kN	Δp <sub>s</sub>	kPa	1600	1250

100 kPa = 1 bar = 10 mWS

Δp<sub>s</sub>: Closing pressure

<sup>1)</sup> Please state when ordering

<sup>S)</sup> Special-kvs-value

## Control valves with electric actuators up to 350°C

## PN 16-40 2.3.1

Flanged connection  
 PN 16 – 40  
 Cast iron  
 Spheroidal graphite  
 Cast steel  
 Stainless steel

with electric actuators  
 MC103/24 • MC103/230  
 MC163/24 • MC163/230  
 MC253/24 • MC253/230  
 MC403/24 • MC403/230  
 MC503/24 • MC503/230  
 MC1003/24 • MC1003/230  
 MC1503/24 • MC1503/230  
 M300-20kN • M300Y-20kN  
 M300-25kN • M300Y-25kN

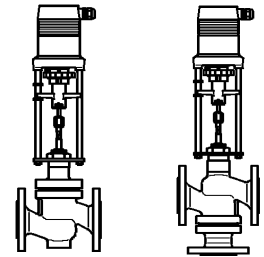

**BR216  
BR225  
BR240S  
BR240E**

**BR316  
BR325  
BR340S  
BR340E**

### PN 16 / PN 25 / PN 40 BR225

DN	15	15	20	25	32	40	50	65 <sup>2)</sup>	80	100 <sup>2)</sup>	125 <sup>2)</sup>	150 <sup>3)</sup>	200 <sup>4)</sup>	
kvs-value	m <sup>3</sup> /h	4 <sup>L</sup>	2.5	6.3 <sup>L</sup>	10	16	25	40	63	100	160	250	400	630
		1.6	5 <sup>S/L</sup>	8 <sup>S/L</sup>	12.5 <sup>S</sup>	20 <sup>S</sup>	31.5 <sup>S</sup>	50 <sup>S</sup>	80 <sup>S</sup>	125 <sup>S</sup>	200 <sup>S</sup>	315 <sup>S</sup>	500 <sup>S</sup>	500 <sup>S</sup>
		1.25	4 <sup>L</sup>	6.3 <sup>L</sup>	10 <sup>L</sup>	16 <sup>L</sup>	25 <sup>L</sup>	40 <sup>L</sup>	63 <sup>L</sup>	100 <sup>L</sup>	160 <sup>L</sup>	250 <sup>L</sup>	400 <sup>L</sup>	400 <sup>L</sup>
		1.0	2.5 <sup>S/L</sup>	5 <sup>S/L</sup>	8 <sup>S/L</sup>	12.5 <sup>S/L</sup>	20 <sup>S/L</sup>	31.5 <sup>S/L</sup>	50 <sup>S/L</sup>	80 <sup>S/L</sup>	125 <sup>S/L</sup>	200 <sup>S/L</sup>	315 <sup>S/L</sup>	315 <sup>S/L</sup>
		0.63												
		0.4												
		0.25												
		0.16												
Stroke	mm	20					30		50		60			
MC103/ 24 MC103/ 230	t <sup>1)</sup>	s	240											
			180											
			80*											
			40											
	Δp <sub>s</sub>	kPa	1250	3500	1250	1050	600	350						
MC163/ 24 MC163/ 230	t <sup>1)</sup>	s	120					180						
			80*					120*						
	Δp <sub>s</sub>	kPa	2400	4000	2400	2050	1250	750	450	300				
MC253/ 24 MC253/ 230	t <sup>1)</sup>	s	100					150		250				
			50*					75*		125*				
	Δp <sub>s</sub>	kPa	4000	4000	4000	3500	2200	1400	850	540	350	200		
MC403/ 24 MC403/ 230	t <sup>1)</sup>	s	15					20		30		40		
			10*					15*		20*		25*		
	Δp <sub>s</sub>	kPa	4000	4000	4000	4000	3700	2400	1500	950	650	400	200	130
MC503/ 24 MC503/ 230	t <sup>1)</sup>	s	100					150		250		300		
			50*					75*		125*		150*		
	Δp <sub>s</sub>	kPa	4000	4000	4000	4000	4000	3150	1950	1250	850	500	290	190
MC1003/ 24	t	s						30		50		60		
MC1003/ 230	Δp <sub>s</sub>	kPa						2150		1500	950	500	350	200
MC1503/ 24	t	s										120		
MC1503/ 230	Δp <sub>s</sub>	kPa										950	700	370

100 kPa = 1 bar = 10 mWS

Δp<sub>s</sub>: Closing pressure

The closing pressure is limited by the nominal pressure.

<sup>1)</sup> Actuating time freely adjustable, presetting is marked with \*

<sup>2)</sup> PN 16 or PN25-40

<sup>3)</sup> PN 16 or PN25

<sup>4)</sup> PN 16

<sup>L)</sup> Available with perforated plug

<sup>S)</sup> Special-kvs-value

## Control valves with electric actuators up to 350°C

## PN 16-40 2.3.1

Flanged connection PN 16 – 40 Cast iron Spheroidal graphite Cast steel Stainless steel	with electric actuators MC103/24 • MC103/230 MC163/24 • MC163/230 MC253/24 • MC253/230 MC403/24 • MC403/230 MC503/24 • MC503/230 MC1003/24 • MC1003/230 MC1503/24 • MC1503/230 M300-20kN • M300Y-20kN M300-25kN • M300Y-25kN
---	---

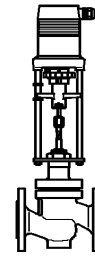

**BR216  
BR225  
BR240S  
BR240E**

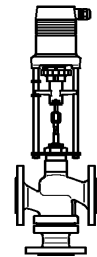

**BR316  
BR325  
BR340S  
BR340E**

### PN 16 / PN 25 / PN 40 BR225

DN		125 <sup>2)</sup>		150 <sup>3)</sup>		200 <sup>4)</sup>	
kvs-value	m <sup>3</sup> /h	250		400		630	
		200 <sup>S</sup>		315 <sup>S</sup>		500 <sup>S</sup>	
		160		250		400	
		125 <sup>S/L</sup>		200 <sup>S/L</sup>		315 <sup>S/L</sup>	
Stroke		mm		60		80	
M300/ M300Y 20 kN	t <sup>1)</sup>	s	155		205		
			80		105		
	Δp <sub>s</sub>	kPa	1400	980	540		
M300/ M300Y 25 kN	t <sup>1)</sup>	s	155		205		
			80		105		
		Δp <sub>s</sub>	kPa	1800	1250	690	

100 kPa = 1 bar = 10 mWS

Δp<sub>s</sub>: Closing pressure

The closing pressure is limited by the nominal pressure.

<sup>1)</sup> Please state when ordering

<sup>2)</sup> PN 16 or PN25-40

<sup>3)</sup> PN 16 or PN25

<sup>4)</sup> PN 16

<sup>L)</sup> Available with perforated plug

<sup>S)</sup> Special-kvs-value



## Control valves with electric actuators up to 350°C

## PN 16-40 2.3.1

Flanged connection  
 PN 16 – 40  
 Cast iron  
 Spheroidal graphite  
 Cast steel  
 Stainless steel

with electric actuators  
 MC103/24 • MC103/230  
 MC163/24 • MC163/230  
 MC253/24 • MC253/230  
 MC403/24 • MC403/230  
 MC503/24 • MC503/230  
 MC1003/24 • MC1003/230  
 MC1503/24 • MC1503/230  
 M300-20kN • M300Y-20kN  
 M300-25kN • M300Y-25kN

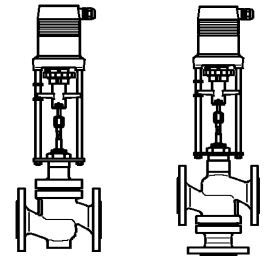

**BR216  
 BR225  
 BR240S  
 BR240E**

**BR316  
 BR325  
 BR340S  
 BR340E**

### PN 16 / PN 25 / PN 40 BR325

DN	15	20	25	32	40	50	65 <sup>2)</sup>	80	100 <sup>2)</sup>	125 <sup>2)</sup>	150 <sup>3)</sup>	200 <sup>4)</sup>			
kvs-value	m <sup>3</sup> /h	4	6.3	10	16	25	40	63	100	160	250	400	630		
		2.5	5	8	12.5	20	31.5	50	80	125	200	315	500		
Stroke	mm	20				30			50		60				
		240				180			80*		40				
MC103/ 24 MC103/ 230	t <sup>1)</sup>	s	1250				1250			1050		600		350	
	Δp <sub>s</sub>	kPa	1250				1250			1050		600		350	
MC163/ 24 MC163/ 230	t <sup>1)</sup>	s	2400				2400			2050		1250		750	
	Δp <sub>s</sub>	kPa	2400				2400			2050		1250		750	
MC253/ 24 MC253/ 230	t <sup>1)</sup>	s	4000				4000			3500		2200		1400	
	Δp <sub>s</sub>	kPa	4000				4000			3500		2200		1400	
MC403/ 24 MC403/ 230	t <sup>1)</sup>	s	4000				4000			3700		2400		1500	
	Δp <sub>s</sub>	kPa	4000				4000			3700		2400		1500	
MC503/ 24 MC503/ 230	t <sup>1)</sup>	s	4000				4000			3150		1950		1250	
	Δp <sub>s</sub>	kPa	4000				4000			3150		1950		1250	
MC1003/ 24 MC1003/ 230	t	s					30			50		60			
	Δp <sub>s</sub>	kPa					2150			1500		950		500	
MC1503/ 24 MC1503/ 230	t	s										120			
	Δp <sub>s</sub>	kPa										950		700	

100 kPa = 1 bar = 10 mWS

Δp<sub>s</sub>: Closing pressure

The closing pressure is limited by the nominal pressure.

<sup>1)</sup> Actuating time freely adjustable, presetting is marked with \*

<sup>2)</sup> PN 16 or PN25-40

<sup>3)</sup> PN 16 or PN25

<sup>4)</sup> PN 16

<sup>5)</sup> Special-kvs-value

## Control valves with electric actuators up to 350°C

**PN 16-40 2.3.1**

Flanged connection PN 16 – 40 Cast iron Spheroidal graphite Cast steel Stainless steel	with electric actuators MC103/24 • MC103/230 MC163/24 • MC163/230 MC253/24 • MC253/230 MC403/24 • MC403/230 MC503/24 • MC503/230 MC1003/24 • MC1003/230 MC1503/24 • MC1503/230 M300-20kN • M300Y-20kN M300-25kN • M300Y-25kN
---	---

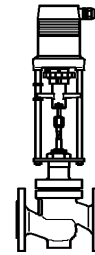

**BR216  
BR225  
BR240S  
BR240E**

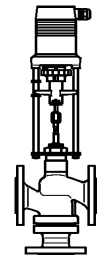

**BR316  
BR325  
BR340S  
BR340E**

### PN 16 / PN 25 / PN 40 BR325

DN			125 <sup>2)</sup>	150 <sup>3)</sup>	200 <sup>4)</sup>
kvs-value	m <sup>3</sup> /h		250	400	630
			200	315	500
			160 <sup>S</sup>	250 <sup>S</sup>	400 <sup>S</sup>
			125 <sup>S</sup>	200 <sup>S</sup>	315 <sup>S</sup>
Stroke		mm	60		80
M300/ M300Y 20 kN	t <sup>1)</sup>	s	155		205
	Δp <sub>s</sub>	kPa	1400	980	540
M300/ M300Y 25 kN	t <sup>1)</sup>	s	155		205
	t <sup>1)</sup>	s	80		105
	Δp <sub>s</sub>	kPa	1800	1250	690

100 kPa = 1 bar = 10 mWS

Δp<sub>s</sub>: Closing pressure

The closing pressure is limited by the nominal pressure.

<sup>1)</sup> Please state when ordering

<sup>2)</sup> PN 16 or PN25-40

<sup>3)</sup> PN 16 or PN25

<sup>4)</sup> PN 16

<sup>S)</sup> Special-kvs-value

## Control valves with electric actuators up to 350°C

## PN 16-40 2.3.1

Flanged connection PN 16 – 40 Cast iron Spheroidal graphite Cast steel Stainless steel	with electric actuators MC103/24 • MC103/230 MC163/24 • MC163/230 MC253/24 • MC253/230 MC403/24 • MC403/230 MC503/24 • MC503/230 MC1003/24 • MC1003/230 MC1503/24 • MC1503/230 M300-20kN • M300Y-20kN M300-25kN • M300Y-25kN
---	---

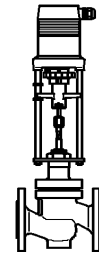

**BR216  
BR225  
BR240S  
BR240E**

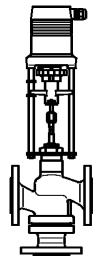

**BR316  
BR325  
BR340S  
BR340E**

### PN 40 BR240S / BR240E

DN		15	15	20	25	32	40	50	65	80	100	125	150	200	250	300								
kvs-value	m <sup>3</sup> /h	4 <sup>L</sup>	2.5	6.3 <sup>L</sup>	10	16	25	40	63	100	160	250	400	630	1000	1250								
			1.6	5 <sup>S/L</sup>	8 <sup>S/L</sup>	12.5 <sup>S</sup>	20 <sup>S</sup>	31.5 <sup>S</sup>	50 <sup>S</sup>	80 <sup>S</sup>	125 <sup>S</sup>	200 <sup>S</sup>	315 <sup>S</sup>	500 <sup>S</sup>	800	1000								
		1.25	4 <sup>L</sup>	6.3 <sup>L</sup>	10 <sup>L</sup>	16 <sup>L</sup>	25 <sup>L</sup>	40 <sup>L</sup>	63 <sup>L</sup>	100 <sup>L</sup>	160 <sup>L</sup>	250 <sup>L</sup>	400 <sup>L</sup>	630 <sup>L</sup>	1000 <sup>L</sup>	1250 <sup>L</sup>								
		1.0	2.5 <sup>S/L</sup>	5 <sup>S/L</sup>	8 <sup>S/L</sup>	12.5 <sup>S/L</sup>	20 <sup>S/L</sup>	31.5 <sup>S/L</sup>	50 <sup>S/L</sup>	80 <sup>S/L</sup>	125 <sup>S/L</sup>	200 <sup>S/L</sup>	315 <sup>S/L</sup>	500 <sup>L</sup>	630 <sup>L</sup>	800 <sup>L</sup>								
		0.63																						
		0.4																						
		0.25																						
		0.16																						
Stroke	mm	20					30			50		60			80									
MC103/ 24 MC103/ 230	t <sup>1)</sup>	s	240																					
			180																					
			80*																					
			40																					
Δp <sub>s</sub>	kPa	1250	3500	1250	1050	600	350																	
MC163/ 24 MC163/ 230	t <sup>1)</sup>	s	120					180																
			80*					120*																
Δp <sub>s</sub>	kPa	2400	4000	2400	2050	1250	750	450	300															
MC253/ 24 MC253/ 230	t <sup>1)</sup>	s	100										150		250									
			50*										75*		125*									
Δp <sub>s</sub>	kPa	4000	4000	4000	3500	2200	1400	850	540	350	200													
MC403/ 24 MC403/ 230	t <sup>1)</sup>	s	15					20			30		40											
			10*					15*			20*		25*											
Δp <sub>s</sub>	kPa	4000	4000	4000	4000	3700	2400	1500	950	650	400	200	130											
MC503/ 24 MC503/ 230	t <sup>1)</sup>	s	100					150			250		300											
			50*					75*			125*		150*											
Δp <sub>s</sub>	kPa	4000	4000	4000	4000	4000	3150	1950	1250	850	500	290	190											
MC1003/ 24 MC1003/ 230	t	s							30		50		60			80								
									2150		1500		950		500		350		200		100			
Δp <sub>s</sub>	kPa											950		700		370		220		150				
MC1503/ 24 MC1503/ 230	t	s											120					160						
													950					700		370		220		150
Δp <sub>s</sub>	kPa											950					700		370		220		150	

100 kPa = 1 bar = 10 mWS

Δp<sub>s</sub>: Closing pressure

<sup>1)</sup> Actuating time freely adjustable, presetting is marked with \*

<sup>L)</sup> Available with perforated plug

<sup>S)</sup> Special-kvs-value

## Control valves with electric actuators up to 350°C

**PN 16-40 2.3.1**

Flanged connection PN 16 – 40 Cast iron Spheroidal graphite Cast steel Stainless steel	with electric actuators MC103/24 • MC103/230 MC163/24 • MC163/230 MC253/24 • MC253/230 MC403/24 • MC403/230 MC503/24 • MC503/230 MC1003/24 • MC1003/230 MC1503/24 • MC1503/230 M300-20kN • M300Y-20kN M300-25kN • M300Y-25kN
---	---

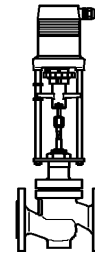

**BR216  
BR225  
BR240S  
BR240E**

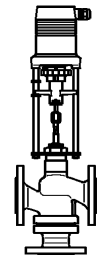

**BR316  
BR325  
BR340S  
BR340E**

### PN 40 BR240S / BR240E

DN		125	150	200	250	300
kvs-value	m <sup>3</sup> /h	250	400	630	1000	1600
		200 <sup>S</sup>	315 <sup>S</sup>	500 <sup>S</sup>	800	1250
		160	250	400	630 <sup>L</sup>	1000
		125 <sup>S/L</sup>	200 <sup>S/L</sup>	315 <sup>S/L</sup>	500 <sup>L</sup>	800 <sup>L</sup>
Stroke		60		80	90	
M300/ M300Y 20 kN	t <sup>1)</sup> s	155		205	225	
		80		105	120	
Δp <sub>s</sub>		1400	980	540	340	240
M300/ M300Y 25 kN	t <sup>1)</sup> s	155		205	225	
		80		105	120	
	Δp <sub>s</sub>		1800	1250	690	440

100 kPa = 1 bar = 10 mWS  
 Δp<sub>s</sub>: Closing pressure

<sup>1)</sup> Please state when ordering  
<sup>L)</sup> Available with perforated plug  
<sup>S)</sup> Special-kvs-value

## Control valves with electric actuators up to 350°C

## PN 16-40 2.3.1

Flanged connection PN 16 – 40 Cast iron Spheroidal graphite Cast steel Stainless steel	with electric actuators MC103/24 • MC103/230 MC163/24 • MC163/230 MC253/24 • MC253/230 MC403/24 • MC403/230 MC503/24 • MC503/230 MC1003/24 • MC1003/230 MC1503/24 • MC1503/230 M300-20kN • M300Y-20kN M300-25kN • M300Y-25kN
---	---

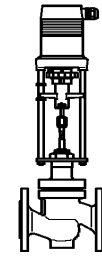

**BR216  
BR225  
BR240S  
BR240E**

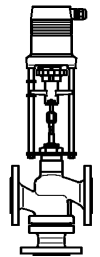

**BR316  
BR325  
BR340S  
BR340E**

### PN 40 R340S / BR340E

DN		15	20	25	32	40	50	65	80	100	125	150	200	250	300		
kvs-value	m³/h	4	6.3	10	16	25	40	63	100	160	250	400	630	1000	1250		
		2.5	5	8	12.5	20	31.5	50	80	125	200	315	500	800	1000		
			4 <sup>s</sup> 2.5 <sup>s</sup>	6.3 <sup>s</sup> 5 <sup>s</sup>	10 <sup>s</sup> 8 <sup>s</sup>	16 <sup>s</sup> 12.5 <sup>s</sup>	25 <sup>s</sup> 20 <sup>s</sup>	40 <sup>s</sup> 31.5 <sup>s</sup>	63 <sup>s</sup> 50 <sup>s</sup>	100 <sup>s</sup> 80 <sup>s</sup>	160 <sup>s</sup> 125 <sup>s</sup>	250 <sup>s</sup> 200 <sup>s</sup>	400 <sup>s</sup> 315 <sup>s</sup>	630 <sup>s</sup> 500 <sup>s</sup>	1000 <sup>s</sup> 800 <sup>s</sup>	1250 <sup>s</sup> 1000 <sup>s</sup>	
Stroke		20					30		50		60			80			
MC103/ 24 MC103/ 230	t <sup>1)</sup>	s	240														
			180														
				80*													
				40													
Δp <sub>s</sub>		kPa		1250	1250	1050	600	350									
MC163/ 24 MC163/ 230	t <sup>1)</sup>	s	120					180									
			80*					120*									
Δp <sub>s</sub>		kPa		2400	2400	2050	1250	750	450	300							
MC253/ 24 MC253/ 230	t <sup>1)</sup>	s	100					150		250							
			50*					75*		125*							
Δp <sub>s</sub>		kPa		4000	4000	3500	2200	1400	850	540	350	200					
MC403/ 24 MC403/ 230	t <sup>1)</sup>	s	15					20		30		40					
			10*					15*		20*		25*					
Δp <sub>s</sub>		kPa		4000	4000	4000	3700	2400	1500	950	650	400	200	130			
MC503/ 24 MC503/ 230	t <sup>1)</sup>	s	100					150		250		300					
			50*					75*		125*		150*					
Δp <sub>s</sub>		kPa		4000	4000	4000	4000	3150	1950	1250	880	540	290	190			
MC1003/ 24 MC1003/ 230	t	s						30		50		60		80			
										2150		1500	950	500	350	200	100
Δp <sub>s</sub>		kPa															
MC1503/ 24 MC1503/ 230	t	s										120		160			
Δp <sub>s</sub>		kPa											950	700	370	220	150

100 kPa = 1 bar = 10 mWS  
 Δp<sub>s</sub>: Closing pressure

<sup>1)</sup> Actuating time freely adjustable, presetting is marked with \*  
<sup>s)</sup> Special-kvs-value

## Control valves with electric actuators up to 350°C

**PN 16-40 2.3.1**

Flanged connection PN 16 – 40 Cast iron Spheroidal graphite Cast steel Stainless steel	with electric actuators MC103/24 • MC103/230 MC163/24 • MC163/230 MC253/24 • MC253/230 MC403/24 • MC403/230 MC503/24 • MC503/230 MC1003/24 • MC1003/230 MC1503/24 • MC1503/230 M300-20kN • M300Y-20kN M300-25kN • M300Y-25kN
---	---

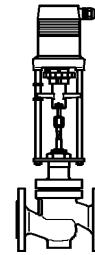

**BR216  
BR225  
BR240S  
BR240E**

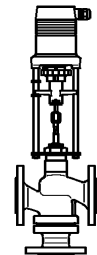

**BR316  
BR325  
BR340S  
BR340E**

### PN 40 BR340S / BR340E

DN		125	150	200	250	300
kvs-value	m <sup>3</sup> /h	250	400	630	1000	1600
		200	315	500	800	1250
		160 <sup>S</sup>	250 <sup>S</sup>	400 <sup>S</sup>	630	1000
		125 <sup>S</sup>	200 <sup>S</sup>	315 <sup>S</sup>	500	800
Stroke		60		80	90	
M300/ M300Y 20 kN	t <sup>1)</sup> s	155		205	225	
		80		105	120	
		Δp <sub>s</sub> kPa		540	340	240
M300/ M300Y 25 kN	t <sup>1)</sup> s	155		205	225	
		80		105	120	
		Δp <sub>s</sub> kPa		1800	1250	690

100 kPa = 1 bar = 10 mWS  
 Δp<sub>s</sub>: Closing pressure

<sup>1)</sup> Please state when ordering  
<sup>S)</sup> Special-kvs-value

## Control valves with electric actuators up to 350°C

PN 16-40 **2.3.1**

Flanged connection  
PN 16 – 40  
Cast iron  
Spheroidal graphite  
Cast steel  
Stainless steel

with electric actuators  
MC103/24 • MC103/230  
MC163/24 • MC163/230  
MC253/24 • MC253/230  
MC403/24 • MC403/230  
MC503/24 • MC503/230  
MC1003/24 • MC1003/230  
MC1503/24 • MC1503/230  
M300-20kN • M300Y-20kN  
M300-25kN • M300Y-25kN

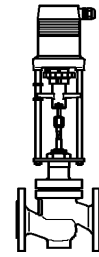

BR216  
BR225  
BR240S  
BR240E

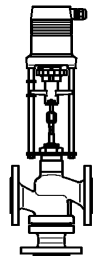

BR316  
BR325  
BR340S  
BR340E

### Drawing

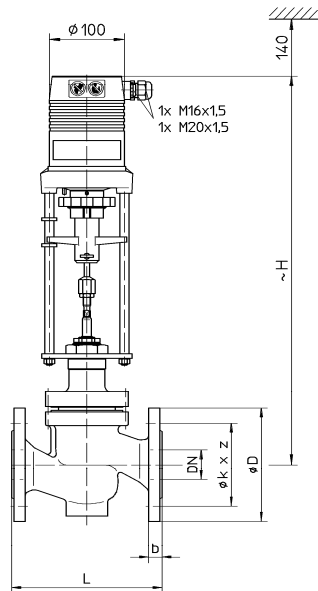

BR2... MC103

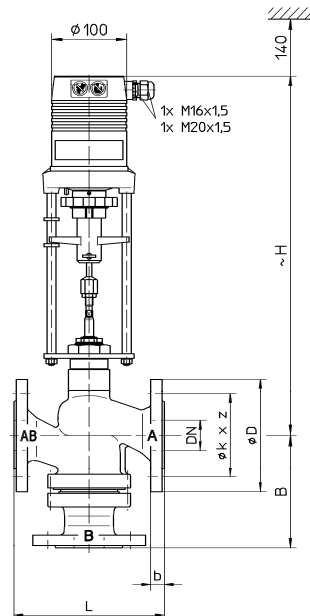

BR3... MC103

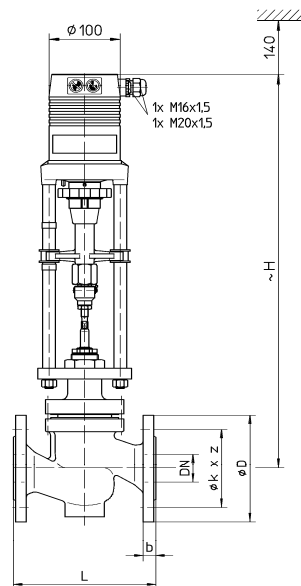

BR2... MC163

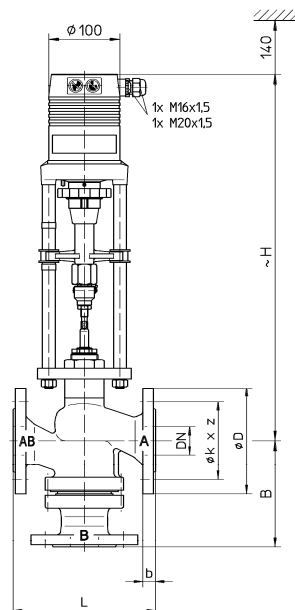

BR3... MC163

## Control valves with electric actuators up to 350°C

PN 16-40 **2.3.1**

Flanged connection  
PN 16 – 40  
Cast iron  
Spheroidal graphite  
Cast steel  
Stainless steel

with electric actuators  
MC103/24 • MC103/230  
MC163/24 • MC163/230  
MC253/24 • MC253/230  
MC403/24 • MC403/230  
MC503/24 • MC503/230  
MC1003/24 • MC1003/230  
MC1503/24 • MC1503/230  
M300-20kN • M300Y-20kN  
M300-25kN • M300Y-25kN

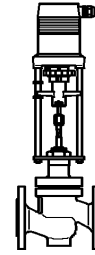

BR216  
BR225  
BR240S  
BR240E

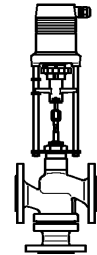

BR316  
BR325  
BR340S  
BR340E

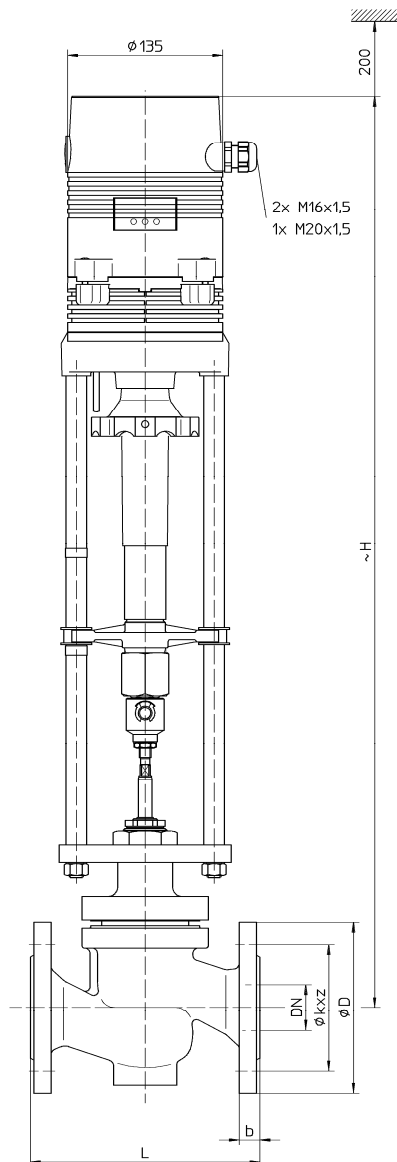

BR2... MC253  
MC403  
MC503  
MC1003  
MC1503

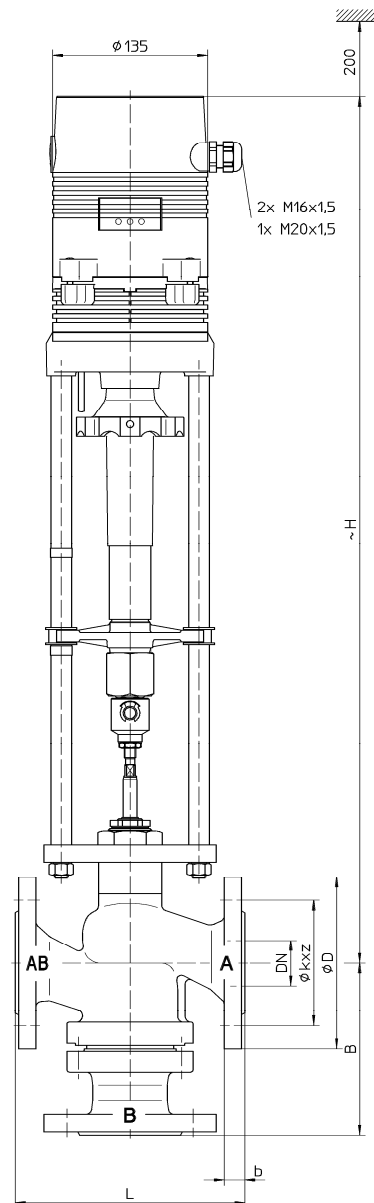

BR3... MC253  
MC403  
MC503  
MC1003  
MC1503



## Control valves with electric actuators up to 350°C

PN 16-40 **2.3.1**

Flanged connection  
PN 16 – 40  
Cast iron  
Spheroidal graphite  
Cast steel  
Stainless steel

with electric actuators  
MC103/24 • MC103/230  
MC163/24 • MC163/230  
MC253/24 • MC253/230  
MC403/24 • MC403/230  
MC503/24 • MC503/230  
MC1003/24 • MC1003/230  
MC1503/24 • MC1503/230  
M300-20kN • M300Y-20kN  
M300-25kN • M300Y-25kN

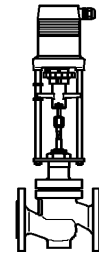

BR216  
BR225  
BR240S  
BR240E

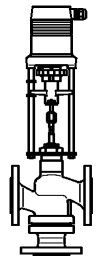

BR316  
BR325  
BR340S  
BR340E

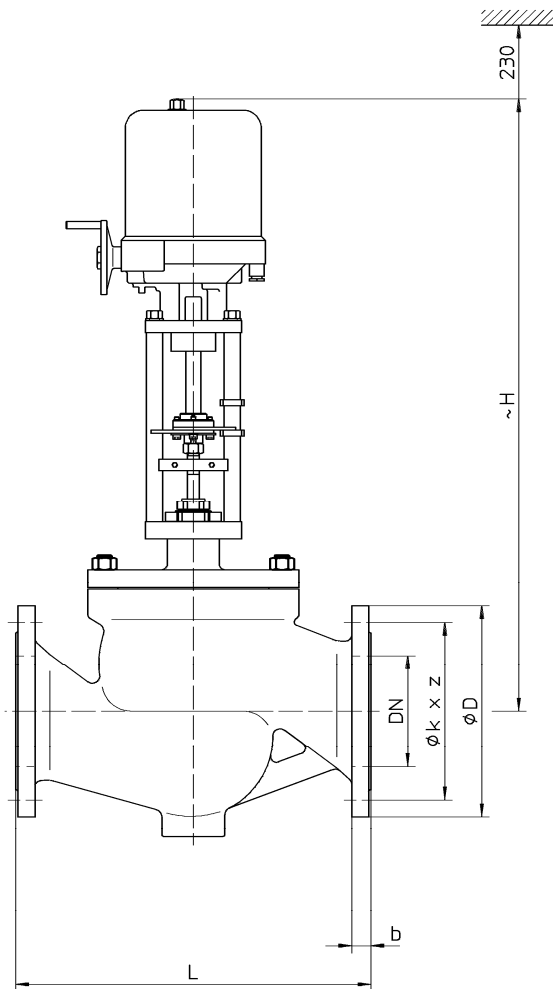

BR2... M300(Y)

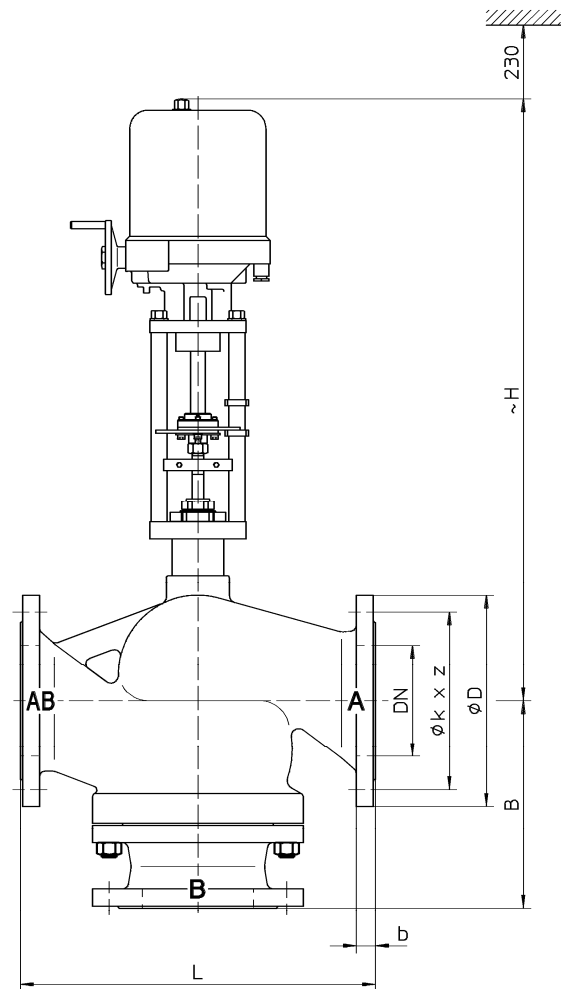

BR3... M300(Y)

**Installation instruction:**

Valve trim could be damaged by dirt in the pipe system. Therefore we recommend the installation of strainers.

## Control valves with electric actuators up to 350°C

**PN 16-40 2.3.1**

Flanged connection  
PN 16 – 40  
Cast iron  
Spheroidal graphite  
Cast steel  
Stainless steel

with electric actuators  
MC103/24 • MC103/230  
MC163/24 • MC163/230  
MC253/24 • MC253/230  
MC403/24 • MC403/230  
MC503/24 • MC503/230  
MC1003/24 • MC1003/230  
MC1503/24 • MC1503/230  
M300-20kN • M300Y-20kN  
M300-25kN • M300Y-25kN

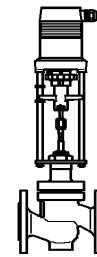

**BR216  
BR225  
BR240S  
BR240E**

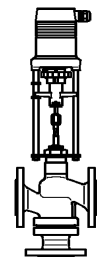

**BR316  
BR325  
BR340S  
BR340E**

### Dimension

#### BR216/BR316 and BR225/BR325

DN		15	20	25	32	40	50	65	80	100	125	150	200 <sup>1)</sup>	250 <sup>1)</sup>	300 <sup>1)</sup>	
L	mm	130	150	160	180	200	230	290	310	350	400	480	600	730	850	
B	mm	130	130	130	150	150	160	170	215	215	260	280	400	450	550	
PN 16	∅ D	mm	95	105	115	140	150	165	185	200	220	250	285	340	405	460
	∅ k	mm	65	75	85	100	110	125	145	160	180	210	240	295	355	410
	z	mm	4x ∅14			4x ∅18				8x ∅18			8x ∅22	12x ∅22	12x ∅26	
	b	mm	16	16	18	18	18	20	20	20	22	24	24	30	32	32
PN 25	∅ D	mm	95	105	115	140	150	165	185	200	235	270	300			
	∅ k	mm	65	75	85	100	110	125	145	160	190	220	250			
	z	mm	4x ∅14			4x ∅18				8x ∅18	8x ∅22	8x ∅26				
	b	mm	16	16	18	18	18	20	20	20	22	24	24			
MC103 24 VAC	BR2...	mm	500	500	500	515	515									
	BR3...	mm	460	460	465	475	475									
MC103 230 VAC	BR2...	mm	525	525	525	540	540									
	BR3...	mm	485	485	490	500	500									
MC163 24 VAC	BR2...	mm	552	537	537	567	567	577	587							
	BR3...	mm	512	512	517	527	527	537	552							
MC163 230 VAC	BR2...	mm	577	577	577	592	592	602	612							
	BR3...	mm	537	537	542	552	552	562	577							
H MC253	BR2...	mm	725	725	725	740	740	750	760	860	905					
	BR3...	mm	685	685	690	700	700	710	725	840	870					
MC403	BR2...	mm	775	775	775	790	790	800	810	905	950	975	1000			
	BR3...	mm	735	735	740	750	750	760	775	885	915	920	940			
MC503	BR2...	mm	725	725	725	740	740	750	760	860	905	930	955			
	BR3...	mm	685	685	690	700	700	710	725	840	870	875	895			
MC1003	BR2...	mm							935	950	995	1020	1045	1150	1210	
	BR3...	mm							900	930	960	965	985	1100	1155	
MC1503	BR2...	mm										1020	1045	1150	1210	1270
	BR3...	mm										965	985	1100	1155	1210
M300(Y)	BR2...	mm										900	925	990	1045	1105
	BR3...	mm										885	905	980	1030	1085

<sup>1)</sup> PN 16

## Control valves with electric actuators up to 350°C

**PN 16-40 2.3.1**

Flanged connection PN 16 – 40 Cast iron Spheroidal graphite Cast steel Stainless steel	with electric actuators MC103/24 • MC103/230 MC163/24 • MC163/230 MC253/24 • MC253/230 MC403/24 • MC403/230 MC503/24 • MC503/230 MC1003/24 • MC1003/230 MC1503/24 • MC1503/230 M300-20kN • M300Y-20kN M300-25kN • M300Y-25kN
---	---

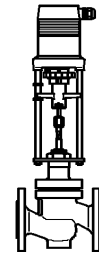

**BR216  
BR225  
BR240S  
BR240E**

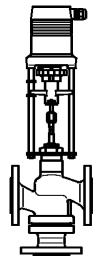

**BR316  
BR325  
BR340S  
BR340E**

### BR240S / BR340S and BR240E / BR340E

DN		15	20	25	32	40	50	65	80	100	125	150	200	250	300		
L	mm	130	150	160	180	200	230	290	310	350	400	480	600	730	850		
B	mm	130	130	130	150	150	160	170	215	215	260	280	400	450	550		
PN 16	∅ D	mm	95	105	115	140	150	165	185	200	220	250	285	340	405	460	
	∅ k	mm	65	75	85	100	110	125	145	160	180	210	240	295	355	410	
	z	mm	4x ∅14			4x ∅18				8x ∅18			8x ∅22	12x ∅22	12x ∅26		
	b	mm	16	18	18	18	18	20	18	20	20	22	22	24	26	28	
PN 25	∅ D	mm	95	105	115	140	150	165	185	200	235	270	300	360	425	485	
	∅ k	mm	65	75	85	100	110	125	145	160	190	220	250	310	370	430	
	z	mm	4x ∅14			4x ∅18				8x ∅18		8x ∅22	8x ∅26		12x ∅26	12x ∅30	16x ∅30
	b	mm	16	18	18	18	18	20	22	24	24	26	28	30	32	34	
PN 40	∅ D	mm	95	105	115	140	150	165	185	200	235	270	300	375	450	515	
	∅ k	mm	65	75	85	100	110	125	145	160	190	220	250	320	385	450	
	z	mm	4x ∅14			4x ∅18				8x ∅18		8x ∅22	8x ∅26		12x ∅30	12x ∅33	16x ∅33
	b	mm	16	18	18	18	18	20	22	24	24	26	28	34	38	42	
MC103 24 VAC	BR2...	mm	500	500	500	515	515										
	BR3...	mm	460	460	465	475	475										
MC103 230 VAC	BR2...	mm	525	525	525	540	540										
	BR3...	mm	485	485	490	500	500										
MC163 24 VAC	BR2...	mm	552	537	537	567	567	577	587								
	BR3...	mm	512	512	517	527	527	537	552								
MC163 230 VAC	BR2...	mm	577	577	577	592	592	602	612								
	BR3...	mm	537	537	542	552	552	562	577								
H MC253	BR2...	mm	725	725	725	740	740	750	760	860	905						
	BR3...	mm	685	685	690	700	700	710	725	840	870						
MC403	BR2...	mm	775	775	775	790	800	800	810	905	950	975	1000				
	BR3...	mm	735	735	740	750	750	760	775	885	915	920	940				
MC503	BR2...	mm	725	725	725	740	740	750	760	860	905	930	955				
	BR3...	mm	685	685	690	700	700	710	725	840	870	875	895				
MC1003	BR2...	mm								935	950	995	1020	1045	1150	1210	
	BR3...	mm								900	930	960	965	985	1100	1155	
MC1503	BR2...	mm											1020	1045	1150	1210	1270
	BR3...	mm											965	985	1100	1155	1210

## Control valves with electric actuators up to 350°C

**PN 16-40 2.3.1**

Flanged connection	with electric actuators
PN 16 – 40	MC103/24 • MC103/230
Cast iron	MC163/24 • MC163/230
Spheroidal graphite	MC253/24 • MC253/230
Cast steel	MC403/24 • MC403/230
Stainless steel	MC503/24 • MC503/230
	MC1003/24 • MC1003/230
	MC1503/24 • MC1503/230
	M300-20kN • M300Y-20kN
	M300-25kN • M300Y-25kN

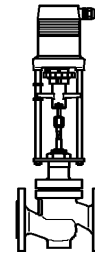

**BR216  
BR225  
BR240S  
BR240E**

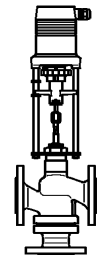

**BR316  
BR325  
BR340S  
BR340E**

M300(Y)	BR2... mm										900	925	990	1045	1105
	BR3... mm										885	905	980	1030	1085

## Control valves with electric actuators up to 350°C

**PN 16-40 2.3.1**

Flanged connection PN 16 – 40 Cast iron Spheroidal graphite Cast steel Stainless steel	with electric actuators MC103/24 • MC103/230 MC163/24 • MC163/230 MC253/24 • MC253/230 MC403/24 • MC403/230 MC503/24 • MC503/230 MC1003/24 • MC1003/230 MC1503/24 • MC1503/230 M300-20kN • M300Y-20kN M300-25kN • M300Y-25kN
---	---

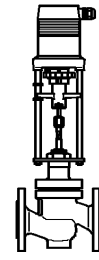

**BR216  
BR225  
BR240S  
BR240E**

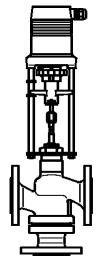

**BR316  
BR325  
BR340S  
BR340E**

### Weight

#### PN 16 / PN 25

DN			15	20	25	32	40	50	65	80	100	125	150	200	250	300	
m	MC103	BR2...	kg	6.5	8.5	9.5	10.5	13.5									
		BR3...	kg	7.5	8.5	10.5	12.5	14.5									
	MC163	BR2...	kg	8	10	11	12	15	17	21							
		BR3...	kg	9	10	12	14	16	20	24							
	MC253 24 VAC	BR2...	kg	11.4	13.4	14.4	15.4	18.4	20.4	24.4	37.4	49.4					
		BR3...	kg	12.4	14.4	15.4	17.4	19.4	23.4	27.4	41.4	52.4					
	MC253 230 VAC	BR2...	kg	12.6	14.6	15.6	16.6	19.6	21.6	25.6	38.6	50.6					
		BR3...	kg	13.6	15.6	16.6	18.6	20.6	24.6	28.6	42.6	53.6					
	MC403	BR2...	kg	13.5	15.5	16.5	17.5	20.5	22.5	26.5	39.5	51.5	70.5	102.5			
		BR3...	kg	14.5	16.5	17.5	19.5	21.5	25.5	29.5	43.5	54.5	82.5	113.5			
	MC503 24 VAC	BR2...	kg	11.4	13.4	14.4	15.4	18.4	20.4	24.4	37.4	49.4	68.4	100.4			
		BR3...	kg	12.4	14.4	15.4	17.4	19.4	23.4	27.4	41.4	52.4	80.4	111.4			
	MC503 230 VAC	BR2...	kg	12.6	14.6	15.6	16.6	19.6	21.6	25.6	38.6	50.6	69.6	101.6			
		BR3...	kg	13.6	15.6	16.6	18.6	20.6	24.6	28.6	42.6	53.6	81.6	112.6			
	MC1003	BR2...	kg							28.5	41.5	53.5	72.5	104.5	241.5	301.5	
		BR3...	kg							31.5	45.5	56.5	84.5	115.5	281.5	346.5	
	MC1503	BR2...	kg									72.5	104.5	241.5	301.5	391.5	
		BR3...	kg									84.5	115.5	281.5	346.5	451.5	
	M300(Y)	BR2...	kg									83	115	252	312	402	
		BR3...	kg									95	126	292	357	462	

## Control valves with electric actuators up to 350°C

**PN 16-40 2.3.1**

Flanged connection  
 PN 16 – 40  
 Cast iron  
 Spheroidal graphite  
 Cast steel  
 Stainless steel

with electric actuators  
 MC103/24 • MC103/230  
 MC163/24 • MC163/230  
 MC253/24 • MC253/230  
 MC403/24 • MC403/230  
 MC503/24 • MC503/230  
 MC1003/24 • MC1003/230  
 MC1503/24 • MC1503/230  
 M300-20kN • M300Y-20kN  
 M300-25kN • M300Y-25kN

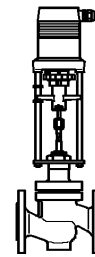

**BR216  
 BR225  
 BR240S  
 BR240E**

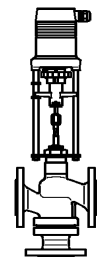

**BR316  
 BR325  
 BR340S  
 BR340E**

### PN 40

DN			15	20	25	32	40	50	65	80	100	125	150	200	250	300
MC103	BR2...	kg	9.5	10.5	12.5	15.5	16.5									
	BR3...	kg	10.5	11.5	13.5	18.5	19.5									
MC163	BR2...	kg	11	12	14	17	18	23	31							
	BR3...	kg	12	13	15	20	21	26	37							
MC253 24 VAC	BR2...	kg	14.4	15.4	17.4	20.4	21.4	26.4	37.4	45.4	60.4					
	BR3...	kg	15.4	16.4	18.4	23.4	24.4	29.4	40.4	52.4	65.4					
MC253 230 VAC	BR2...	kg	15.6	16.6	18.6	21.6	22.6	27.6	35.6	46.6	61.6					
	BR3...	kg	16.6	17.6	19.6	24.6	25.6	30.6	41.6	53.6	66.6					
MC403	BR2...	kg	16.5	17.5	19.5	22.5	23.5	28.5	39.5	47.5	62.5	76.5	111.5			
	BR3...	kg	17.5	18.5	20.5	25.5	26.5	31.5	42.5	54.5	67.5	88.5	130.5			
MC503 24 VAC	BR2...	kg	14.4	15.4	17.4	20.4	21.4	26.4	37.4	45.4	60.4	74.4	109.4			
	BR3...	kg	15.4	16.4	18.4	23.4	24.4	29.4	40.4	52.4	65.4	86.4	128.4			
MC503 230 VAC	BR2...	kg	15.6	16.6	18.6	21.6	22.6	27.6	35.6	46.6	61.6	75.6	110.6			
	BR3...	kg	16.6	17.6	19.6	24.6	25.6	30.6	41.6	53.6	66.6	87.6	129.6			
MC1003	BR2...	kg							41.5	49.5	64.5	78.5	113.5	271.5	366.5	
	BR3...	kg							44.5	56.5	69.5	90.5	132.5	311.5	426.5	
MC1503	BR2...	kg										78.5	113.5	271.5	366.5	471.5
	BR3...	kg										90.5	132.5	311.5	426.5	551.5
M300(Y)	BR2...	kg										89	124	282	377	482
	BR3...	kg										101	143	322	437	562

Technische Änderungen vorbehalten • Subject to change without notice • Changements techniques sous réserve