

Manual

Modbus RTU

Protocol description
for the product line DE90

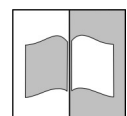

Masthead

Manufacturer:**FISCHER Mess- und Regeltechnik GmbH**Bielefelderstr. 37a
D-32107 Bad SalzufenTelephone: +49 5222 974 0
Telefax: +49 5222 7170eMail: info@fischermesstechnik.deweb: www.fischermesstechnik.de**Technical editorial team:**

Documentation representative: T. Malischewski

Technical editor: R. Kleemann

All rights, also those to the translation, reserved. No part of this document may be reproduced or processed, duplicated or distributed using electronic systems or any other form (print, photocopy, microfilm or another process) without the written consent of the company FISCHER Mess- und Regeltechnik GmbH, Bad Salzufen.

Reproduction for internal use is expressly allowed.

Brand names and procedures are used for information purposes only and do not take the respective patent situation into account. Great care was taken when compiling the texts and illustrations; Nevertheless, errors cannot be ruled out. The company FISCHER Mess- und Regeltechnik GmbH will not accept any legal responsibility or liability for this.

Subject to technical amendments.



© FISCHER Mess- und Regeltechnik 2019

Version history

Rev. ST4-A 08/19	Version 1 (first edition)
Rev. ST4-B 09/23	Version 2 (correction - error signals)
Rev. ST4-C 03/24	Version 3 (update for firmware >V1.41)

Table of contents

1 Introduction	4
1.1 Modbus infrastructure.....	4
1.2 Modbus RTU Protocol.....	4
1.3 Modbus Transaction.....	5
1.4 Modbus Frame	5
1.5 Modbus data transmission	6
2 Functions	7
2.1 General.....	7
2.2 Function Code [03] "Read Holding Register"	8
2.3 Function Code [04] "Read Input Register"	10
2.4 Function Code [06] "Write Single Register".....	12
2.5 Function Code [16] "Write Multiple Registers"	14
2.6 Function Code [17] "Report Server ID"	15
3 Data types	17
4 Addresses	18
4.1 Measured values	19
4.2 Configuration channel 1 (differential pressure)	21
4.3 Configuration channel 2 (differential pressure)	27
4.4 Configuration channel 3	33
4.4.1 Mode = inactive.....	33
4.4.2 Mode = difference	33
4.4.3 Mode = diff. + flow rate	35
4.4.4 Mode = diff. + table	37
4.4.5 Mode = Dyn. filter monitoring	42
4.5 Configuration of switch outputs	46
4.6 Configuration display.....	48
4.7 Error indicator	49
5 Attachments	50
5.1 Literature	50
Glossary.....	51

1 Introduction

The Modbus protocol is a communication protocol that is based on a Master/ Slave architecture. All FISCHER products work in the operating mode Modbus RTU.

This manual is designed for readers with a basic understanding of the Modbus protocol. There are references to relevant specialist literature about this topic at the end of this manual.

1.1 Modbus infrastructure

Communication with the FISCHER units requires a serial two-wire bus (2W) in compliance with the EIA/TIA-485 standard. All connected units must be connected to a joint reference potential by means of a third (common) line. The bus is connected using a 120Ω 0.5W resistor. The pull up/down resistors are usually set on the master. Usually, up to 32 slaves can be connected without a repeater.

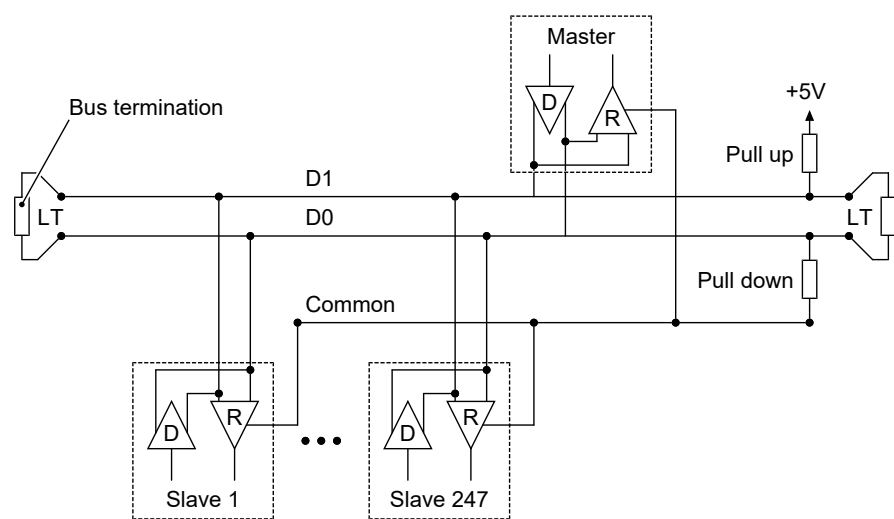

Fig. 1: Modbus infrastructure



NOTICE

Passive TAP

If the units are connected via a Passive TAP (e.g. T-adapter connection), the units can be disconnected from the bus without interrupting the bus.

1.2 Modbus RTU Protocol

The Modbus RTU transfers data in a binary form. A single master and up to 247 slaves can be connected at the same time to the serial Modbus.

The following basic rules apply.

- A Modbus transaction is only initialised by the Master.
- At the same time, only one Modbus transaction takes place.
- The Slave never sends data without a request from the Master.
- Slaves cannot communicate with each other.

1.3 Modbus Transaction

A Modbus transaction comprises two parts. A request from the Master and a response from the Slave.

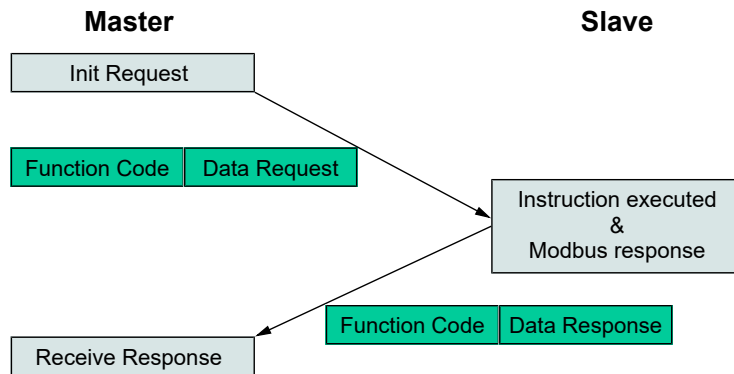

Fig. 2: Error-free request/response cycle

If an error occurs during a Modbus transaction, the Function Code is replaced with a special Function Code with an error indicator in the Modbus Response message and a more detailed description of the error in the data field is sent.

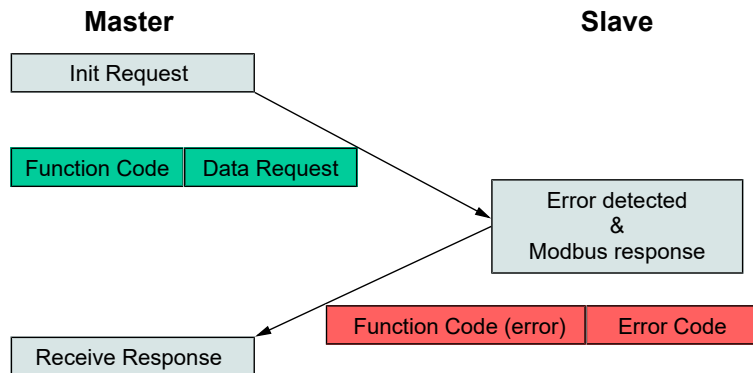

Fig. 3: Faulty request/response cycle

1.4 Modbus Frame

A Modbus data frame comprises two components.

- Protocol Data Unit (PDU)
- Application Data Unit (ADU)

The inner data structure is the PDU and additional data fields are added for the encapsulation of the frame in the respective protocol of the data transmission.

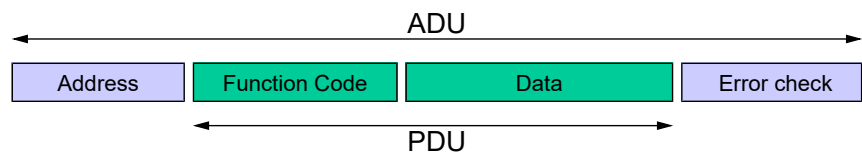

Fig. 4: MODBUS Frame

In the Modbus RTU protocol, the address field contains the Slave address. The address space comprises the addresses 1 to 255. If the Slave sends a Response, it positions its own address in the address field. This means that the Master 'knows' which Slave is sending. The Function Code states which action needs to be carried out. The following data field contains the Request and Response parameters. The error check field contains the result of a CRC review of the content of the transmission.

1.5 Modbus data transmission

In the RTU mode, each message is sent as a continuous binary flow of characters via the serial bus.

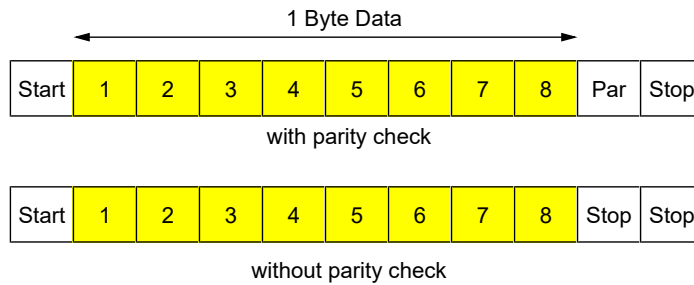

Fig. 5: Bit Sequence

The Even Parity is set as the default value for the parity bit. But an Odd Parity and No Parity can also be used. If No Parity is used, a further stop bit is added.

A Modbus message is set by the transferring unit in a so-called frame. The maximum size of a message is 256 byte. Start and end point of a frame are well defined. This allows the receiving unit to recognise the start and end of a message.

A transmission starts with a break of at least 3.5 characters (char). Then the frames are sent. Each frame must be followed by a pause interval ($t_{3.5}$) with a length of at least 3.5 characters before the next frame is sent. There must be a pause interval ($t_{1.5}$) between two characters with a maximum length of 1.5 characters. The entire transmission must be sent as a continuous flow of characters.

If the idle intervals are not satisfied, the character flow stops and the transmission is declared invalid.

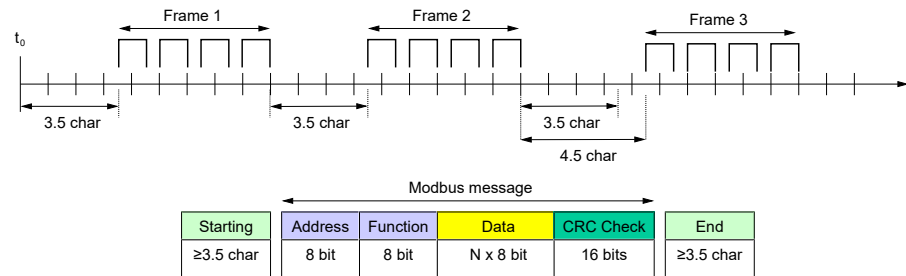

Fig. 6: Modbus Message Frame

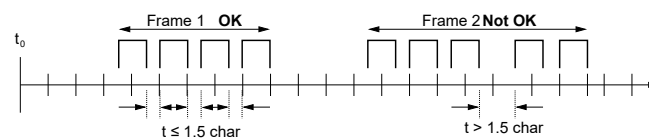

Fig. 7: Faulty transmission (example)

2 Functions

2.1 General

The Modbus protocol has a series of options for access to the data:

Type	Access	File	Code
Details	16 Bit	Read Holding Register	03
		Read Input Register	04
		Write Single Register	06
		Write Multiple Register	16
Di- gnostics		Report Server ID	17

2.2 Function Code [03] "Read Holding Register"

This Function Code is used to read the Holding Register. The maximum possible number of registers that can be addressed in one message is 125.

Request

The request contains the address of the first register that is to be read and the number of registers that need to be read. The addressing of the register starts with 0; the numbering of the registers starts with 1.

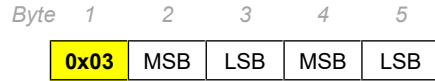

Byte	Field name	Size	Value range
1	Function Code	1 byte	0x03
2.3	Start Address	2 bytes	0x0000 to 0xFFFF
4.5	Number of registers	2 bytes	0x0001 to 0x007D (1...125)

Response

The response contains two bytes for each read register; therefore the number of bytes is twice the number of registers (N).

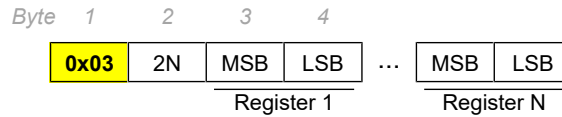

Byte	Field name	Size	Value range
1	Function Code	1 byte	0x03
2	Number of bytes	2 bytes	2N
3.4	Holding Register	N x 2 Byte	16 Bit value

Error

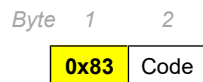

Byte	Field name	Size	Value range
1	Function Code (error)	1 byte	0x83
2	Error code	1 byte	Code see table

The following error codes are possible:

0x01	The function is not supported
0x02	An invalid address is referenced
0x03	The request does not correspond to the expected format; the number of requested registers is greater than 125

Example:

- Export Holding Register 108 to 110
- Content Register 108= 0x000A
- Content Register 109= 0x000B
- Content Register 110= 0x000C

	Byte	1	2	3	4	5	6	7	8
Request		0x03	0x00	0x6B	0x00	0x03			
Response		0x03	0x06	0x00	0x0A	0x00	0x0B	0x00	0x0C

Request		Response	
Field name	Value	Field name	Value
Function Code	0x03	Function Code	0x03
Start Address MSB	0x00	Number of bytes	0x06
Start Address LSB	0x6B	Holding Register 108 MSB	0x00
Number of Registers MSB	0x00	Holding Register 108 LSB	0x0A
Number of Registers LSB	0x03	Holding Register 109 MSB	0x00
		Holding Register 109 LSB	0x0B
		Holding Register 110 MSB	0x00
		Holding Register 110 LSB	0x0C

2.3 Function Code [04] "Read Input Register"

This Function Code is used to read the input register. The maximum possible number of registers that can be addressed in one message is 125.

Request

The request contains the address of the first register that is to be read and the number of registers that need to be read. The addressing of the register starts with 0; the numbering of the registers starts with 1.

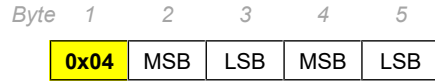

Byte	Field name	Size	Value range
1	Function Code	1 byte	0x04
2.3	Start Address	2 bytes	0x0000 to 0xFFFF
4.5	Number of registers	2 bytes	0x0001 to 0x007D (1...125)

Response

The response contains two bytes for each read register; therefore the number of bytes is twice the number of registers.

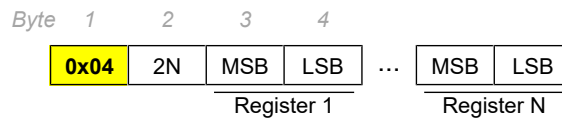

Byte	Field name	Size	Value range
1	Function Code	1 byte	0x04
2	Number of bytes	2 bytes	2N
3.4	Content Register	N x 2 Byte	16 Bit value

Error

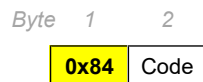

Byte	Field name	Size	Value range
1	Function Code (error)	1 byte	0x84
2	Error code	1 byte	Code see table

The following error codes are possible:

0x01	The function is not supported
0x02	An invalid address is referenced
0x03	The request does not correspond to the expected format; the number of requested registers is greater than 125

Example:

- Export Content Register 9
- Content Register 9= 0x000A

	Byte	1	2	3	4	5
Request		0x04	0x00	0x08	0x00	0x01
Response		0x04	0x02	0x00	0x0A	

Request		Response	
Field name	Value	Field name	Value
Function Code	0x04	Function Code	0x04
Start Address MSB	0x00	Number of bytes	0x02
Start Address LSB	0x08	Input Register 9 MSB	0x00
Number of Registers MSB	0x00	Input Register 9 LSB	0x0A
Number of Registers LSB	0x01		

2.4 Function Code [06] "Write Single Register"

This Function Code is used to write a single Holding register.

Request

The request contains the address of the register that is to be written and value that is to be written.

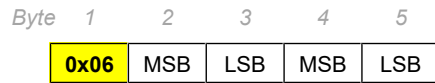

Byte	Field name	Size	Value range
1	Function Code	1 byte	0x06
2.3	Register Address	2 bytes	0x0000 to 0xFFFF
4.5	Register Value	2 bytes	0x0000 to 0xFFFF

Response

The response contains the address register and the written value.

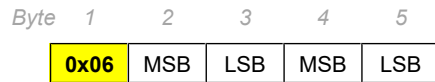

Byte	Field name	Size	Value range
1	Function Code	1 byte	0x06
2	Register Address	2 bytes	0x0000 to 0xFFFF
3.4	Register Value	2 bytes	0x0000 to 0xFFFF

Error

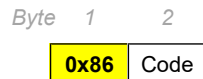

Byte	Field name	Size	Value range
1	Function Code (error)	1 byte	0x86
2	Error code	1 byte	Code see table

The following error codes are possible:

0x01	The function is not supported
0x02	An invalid address is referenced
0x03	The request does not correspond to the expected format

Example:

- Write register 2
- Value that needs to be written = 0x0003

	Byte	1	2	3	4	5
Request		0x06	0x00	0x01	0x00	0x03
Response		0x06	0x00	0x01	0x00	0x03

Request		Response	
Field name	Value	Field name	Value
Function Code	0x06	Function Code	0x06
Register Address MSB	0x00	Register Address MSB	0x00
Register Address LSB	0x01	Register Address LSB	0x01
Register Value MSB	0x00	Register Value MSB	0x00
Register Value LSB	0x03	Register Value LSB	0x03

2.5 Function Code [16] "Write Multiple Registers"

This Function Code is used to write a block of sequential registers. The maximum possible number of registers that can be addressed in one message is 123.

Request

The request contains the address of the first register that is to be written and the number of registers that need to be written. The addressing of the register starts with 0; the numbering of the registers starts with 1.

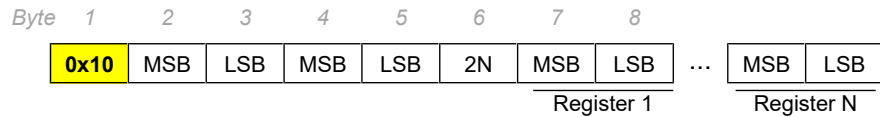

Byte	Field name	Size	Value range
1	Function Code	1 byte	0x10
2.3	Start Address	2 bytes	0x0000 to 0xFFFF
4.5	Number of registers	2 bytes	0x0001 to 0x007B (1...123)
6	Number of bytes	1 byte	2 x N
7.8	Register Value	N x 2 Byte	Value

Response

The response contains the start address and the number of written registers.

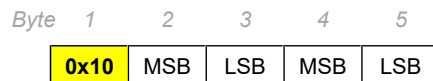

Byte	Field name	Size	Value range
1	Function Code	1 byte	0x10
2.3	Start Address	2 bytes	0x0000 to 0xFFFF
4.5	Number of Registers	2 bytes	0x0001 to 0x007B (1...123)

Error

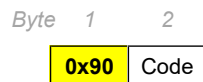

Byte	Field name	Size	Value range
1	Function Code (error)	1 byte	0x90
2	Error code	1 byte	Code see table

The following error codes are possible:

0x01	The function is not supported
0x02	An invalid address is referenced
0x03	The request does not correspond to the expected format; the number of requested registers is greater than 123; the number of data bytes does not match the number of registers

Example:

- Write 2 registers
- Start Address = 0x0001
- Content Register 2= 0x000A
- Content Register 3= 0x0102

	Byte	1	2	3	4	5	6	7	8	9	10
Request		0x10	0x00	0x01	0x00	0x02	0x04	0x00	0x0A	0x01	0x02
Response		0x10	0x00	0x01	0x00	0x02					

Request		Response	
Field name	Value	Field name	Value
Function Code	0x10	Function Code	0x10
Start Address MSB	0x00	Start Address MSB	0x00
Start Address LSB	0x01	Start Address LSB	0x01
Number of Registers MSB	0x00	Number of Registers MSB	0x00
Number of Registers LSB	0x02	Number of Registers LSB	0x02
Number of bytes	0x04		
Register Value MSB	0x00		
Register Value LSB	0x0A		
Register Value MSB	0x01		
Register Value LSB	0x02		

2.6 Function Code [17] "Report Server ID"

The Function Code allows the query of unit-specific data.

The response only contains the Function Code.

Request

Byte 1

0x11

Byte	Field name	Size	Value range
1	Function Code	1 byte	0x11

Response

The response comprises two data bytes. The last byte is always 0xFF.

Byte 1 2 3 4

0x11	0x02	Byte1	0xFF
------	------	-------	------

Byte	Field name	Size	Value range
1	Function Code	1 byte	0x11
2	Number of bytes	1 byte	0x02
3	Byte 1	1 byte	Code see table
4	End	1 byte	0xFF

Dev.	Byte 1
DE90	0x01

Error

Byte 1 2

0x91	Code
------	------

Byte	Field name	Size	Value range
1	Function Code (error)	1 byte	0x91
2	Error code	1 byte	Code see table

The following error codes are possible:

0x01	The function is not supported
0x03	The request does not correspond to the expected format

3 Data types

3.1 Integer (16 Bit)

- Standard format for register
- Comprises two bytes in a Modbus message
- The higher-valued byte (Bits 8 to 15) is always sent first
- The two-complement format is used for integers with a preceding sign.

	Value range
unsigned Integer	0 ... 65535
signed Integer	-32768 ... +32767

3.2 Float

- Floating point numbers are transferred in the IEEE-475 Single Precision format.
- It comprises two registers (four bytes).
- The byte sequence can be changed between the Big Endian- (the value with the highest value first) and the Little Endian format (the value with the lowest value first).

For example:

$1234.56_{10} = 449A51EC_{16}$

Format	Reg. 1 MSB	Reg. 1 LSB	Reg. 2 MSB	Reg. 2 LSB
Big Endian	0x44	0x9A	0x51	0xEC
Little Endian	0xEC	0x51	0x9A	0x44

3.3 Character

- Character strings are transmitted with two characters per register.
- The preceding character is stored in the most significant byte (MSB) and the following character in the least significant byte (LSB) of the register.
- For strings with odd length the last character is always a zero character (0x00).

Example:

Character string = "FISCHER"

Reg. 1 MSB	Reg. 1 LSB	Reg. 2 MSB	Reg. 2 LSB	Reg. 3 MSB	Reg. 3 LSB	Reg. 4 MSB	Reg. 4 LSB
'F'	'I'	'S'	'C'	'H'	'E'	'R'	'\0'
0x46	0x49	0x53	0x43	0x48	0x45	0x52	0x00

4 Addresses

The following abbreviations are used:

Data type	Abbreviation	Description
Float	Float	Floating point number
Unsigned integer	UInt	Integer without sign
Signed integer	SInt	Integer with sign
Character	Char	Character string

Other abbreviations		
	BMR	Basic measuring range (see type plate)
	MR	Measuring range determined by the parameters MBA and MBE
	MRS	Measuring range start
	MRE	Measuring range end
	CoTH	Colour change (threshold)

4.1 Measured values

Reg.	Address		Length	Format	Category	Measured values	Access	
	Dec.	Hex.					Read	Write
1	0	0x0000	2	Float		Measured value channel 1	x	
2	1	0x0001						
3	2	0x0002	1	SInt		Colour change channel 1	x	
					Value	-2: low / red		
					Value	-1: low / yellow		
					Value	0: ok /green		
					Value	1: high / yellow		
					Value	2: high / red		
4	3	0x0003	1	SInt		Error signal channel 1	x	
					Value	0: error		
					Value	1: no error		
5	4	0x0004	2	Float		Measured value channel 2	x	
6	5	0x0005						
7	6	0x0006	1	SInt		Colour change channel 2	x	
					Value	-2: low / red		
					Value	-1: low / yellow		
					Value	0: ok /green		
					Value	1: high / yellow		
					Value	2: high / red		
8	7	0x0007	1	SInt		Error signal channel 2	x	
					Value	0: error		
					Value	1: no error		
9	8	0x0008	2	Float		Measured value channel 3	x	
10	9	0x0009						
11	10	0x000A	1	SInt		Colour change channel 3	x	
					Value	-2: low / red		
					Value	-1: low / yellow		
					Value	0: ok /green		
					Value	1: high / yellow		
					Value	2: high / red		
12	11	0x000B	1	SInt		Error signal channel 3	x	
					Value	0: error		
					Value	1: no error		

Reg.	Address		Length	Format	Category	Measured values	Access		
	Dec.	Hex.					Read	Write	
13	12	0x00C	1	SInt		Switch output 1	x		
						Value			0: off
						Value			1: on
14	13	0x00D	1	SInt		Switch output 2	x		
						Value			0: off
						Value			1: on
15	14	0x00E	1	SInt		Switch output 3	x		
						Value			0: off
						Value			1: on
16	15	0x00F	1	SInt		Switch output 4	x		
						Value			0: off
						Value			1: on

4.2 Configuration channel 1 (differential pressure)

Reg.	Address		Length	Format	Category	Parameters/value	Access	
	Dec.	Hex.					Read	Write
1001	1000	0x03E8	1	UInt		Mode C1	x	x
					Value	0: Linear characteristic		
					Value	1: Flow rate		
					Value	2: Table		
					Value	3: Volume flow		
					Value	4: Linear function		
1002	1001	0x03E9	1	UInt		Measuring range C1 unit	x	x
					Value	0: Pa		
					Value	1: kPa		
					Value	2: MPa		
					Value	3: bar		
					Value	4: mbar		
					Value	5: mmHg		
					Value	6: mmH ₂ O		
					Value	7: inH ₂ O		
					Value	8: psi		
1003	1002	0x03EA	2	Float		Measuring range C1 start	x	x
1004	1003	0x03EB			Value	GMB start...end		
1005	1004	0x03EC	2	Float		Measuring range C1 end	x	x
1006	1005	0x03ED			Value	GMB start...end		
1007	1006	0x03EE	1	UInt		Damping C1	x	x
					Value	0 ... 30 s		
1008	1007	0x03EF	2	Float		Offset C1	x	x
1009	1008	0x03F0			Value	- $\frac{1}{3}$ GMB ... + $\frac{1}{3}$ GMB		
1010	1009	0x03F1	2	Float		Zero-point window C1	x	x
1011	1010	0x03F2			Value	0 ... + $\frac{1}{3}$ GMB		
1012	1011	0x03F3	1	UInt		Limit C1	x	x
					Value	0: Off		
					Value	1: On		
1013	1012	0x03F4	1	SInt		Number format C1	x	x
					Value	0: ± 123456		
					Value	1: ± 12345.6		
					Value	2: ± 1234.45		
					Value	3: ± 123.456		
					Value	4: ± 12.3456		
					Value	5: ± 1.23456		

Reg.	Address		Length	Format	Category	Parameters/value	Access	
	Dec.	Hex.					Read	Write
1014	1013	0x03F5	2	Float		Colour change C1 red–green	x	x
1015	1014	0x03F6						
					Value	MBA –50% ... FW green-red		
1016	1015	0x03F7	2	Float		Colour change C1 green–red	x	x
1017	1016	0x03F8						
					Value	FW red-green ... MBE +50%		
1018	1017	0x03F9	2	Float		Colour change C1 red–yellow	x	x
1019	1018	0x03FA						
					Value	MBA –50% ... FW yellow-green		
1020	1019	0x03FB	2	Float		Colour change C1 yellow–green	x	x
1021	1020	0x03FC						
					Value	FW red-yellow ... FW green-yellow		
1022	1021	0x03FD	2	Float		Colour change C1 green–yellow	x	x
1023	1022	0x03FE						
					Value	FW yellow-green ... FW yellow-red		
1024	1023	0x03FF	2	Float		Colour change C1 yellow–red	x	x
1025	1024	0x0400						
					Value	FW green-yellow ... MB +50%		
1026	1025	0x0401	2	Float		Colour change C1 hysteresis	x	x
1027	1026	0x0402						
					Value	0.1% ... 10% MB		
1028	1027	0x0403	1	UInt		Colour change C1 delay on	x	x
					Value	0 ... 100 s		
1029	1028	0x0404	1	UInt		Colour change C1 delay off	x	x
					Value	0 ... 100 s		
Characteristic: Flow rate								
1030	1029	0x0405	3	Char		Display C1 unit	x	x
1031	1030	0x0406						
1032	1031	0x0407						
					Value	5 characters		
1033	1032	0x0408	2	Float		Display C1 start	x	x
1034	1033	0x0409						
					Value	–999999 ... +999999		
1035	1034	0x040A	2	Float		Display C1 end	x	x
1036	1035	0x040B						
					Value	–999999 ... +999999		
Characteristic: Table								
1037	1036	0x040C	3	Char		Display C1 unit	x	x
1038	1037	0x040D						
1039	1038	0x040E						
					Value	5 characters		

Reg.	Address		Length	Format	Category	Parameters/value	Access	
	Dec.	Hex.					Read	Write
1040	1039	0x040F	1	UInt		Number of value pairs	x	x
					Value	2 ... 30		
1041	1040	0x0410	2	Float		Input value 1	x	x
1042	1041	0x0411			Value	MBA ... MBE		
						<i>(the same range applies to all values below)</i>		
1043	1042	0x0412	2	Float		Input value 2	x	x
1044	1043	0x0413						
1045	1044	0x0414	2	Float		Input value 3	x	x
1046	1045	0x0415						
1047	1046	0x0416	2	Float		Input value 4	x	x
1048	1047	0x0417						
1049	1048	0x0418	2	Float		Input value 5	x	x
1050	1049	0x0419						
1051	1050	0x041A	2	Float		Input value 6	x	x
1052	1051	0x041B						
1053	1052	0x041C	2	Float		Input value 7	x	x
1054	1053	0x041D						
1055	1054	0x041E	2	Float		Input value 8	x	x
1056	1055	0x041F						
1057	1056	0x0420	2	Float		Input value 9	x	x
1058	1057	0x0421						
1059	1058	0x0422	2	Float		Input value 10	x	x
1060	1059	0x0423						
1061	1060	0x0424	2	Float		Input value 11	x	x
1062	1061	0x0425						
1063	1062	0x0426	2	Float		Input value 12	x	x
1064	1063	0x0427						
1065	1064	0x0428	2	Float		Input value 13	x	x
1066	1065	0x0429						
1067	1066	0x042A	2	Float		Input value 14	x	x
1068	1067	0x042B						
1069	1068	0x042C	2	Float		Input value 15	x	x
1070	1069	0x042D						
1071	1070	0x042E	2	Float		Input value 16	x	x
1072	1071	0x042F						
1073	1072	0x0430	2	Float		Input value 17	x	x
1074	1073	0x0431						
1075	1074	0x0432	2	Float		Input value 18	x	x
1076	1075	0x0433						
1077	1076	0x0434	2	Float		Input value 19	x	x
1078	1077	0x0435						
1079	1078	0x0436	2	Float		Input value 20	x	x
1080	1079	0x0437						

Reg.	Address		Length	Format	Category	Parameters/value	Access	
	Dec.	Hex.					Read	Write
1081	1080	0x0438	2	Float		Input value 21	x	x
1082	1081	0x0439						
1083	1082	0x043A	2	Float		Input value 22	x	x
1084	1083	0x043B						
1085	1084	0x043C	2	Float		Input value 23	x	x
1086	1085	0x043D						
1087	1086	0x043E	2	Float		Input value 24	x	x
1088	1087	0x043F						
1089	1088	0x0440	2	Float		Input value 25	x	x
1090	1089	0x0441						
1091	1090	0x0442	2	Float		Input value 26	x	x
1092	1091	0x0443						
1093	1092	0x0444	2	Float		Input value 27	x	x
1094	1093	0x0445						
1095	1094	0x0446	2	Float		Input value 28	x	x
1096	1095	0x0447						
1097	1096	0x0448	2	Float		Input value 29	x	x
1098	1097	0x0449						
1099	1098	0x044A	2	Float		Input value 30	x	x
1100	1099	0x044B						
1101	1100	0x044C	2	Float		Display value 1	x	x
1102	1101	0x044D						
						Value	-999999 ... +999999	
						<i>(the same range applies to all values below)</i>		
1103	1102	0x044E	2	Float		Display value 2	x	x
1104	1103	0x044F						
1105	1104	0x0450	2	Float		Display value 3	x	x
1106	1105	0x0451						
1107	1106	0x0452	2	Float		Display value 4	x	x
1108	1107	0x0453						
1109	1108	0x0454	2	Float		Display value 5	x	x
1110	1109	0x0455						
1111	1110	0x0456	2	Float		Display value 6	x	x
1112	1111	0x0457						
1113	1112	0x0458	2	Float		Display value 7	x	x
1114	1113	0x0459						
1115	1114	0x045A	2	Float		Display value 8	x	x
1116	1115	0x045B						
1117	1116	0x045C	2	Float		Display value 9	x	x
1118	1117	0x045D						
1119	1118	0x045E	2	Float		Display value 10	x	x
1120	1119	0x045F						
1121	1120	0x0460	2	Float		Display value 11	x	x
1122	1121	0x0461						

Reg.	Address		Length	Format	Category	Parameters/value	Access	
	Dec.	Hex.					Read	Write
1123	1122	0x0462	2	Float		Display value 12	x	x
1124	1123	0x0463						
1125	1124	0x0464	2	Float		Display value 13	x	x
1126	1125	0x0465						
1127	1126	0x0466	2	Float		Display value 14	x	x
1128	1127	0x0467						
1129	1128	0x0468	2	Float		Display value 15	x	x
1130	1129	0x0469						
1131	1130	0x046A	2	Float		Display value 16	x	x
1132	1131	0x046B						
1133	1132	0x046C	2	Float		Display value 17	x	x
1134	1133	0x046D						
1135	1134	0x046E	2	Float		Display value 18	x	x
1136	1135	0x046F						
1137	1136	0x0470	2	Float		Display value 19	x	x
1138	1137	0x0471						
1139	1138	0x0472	2	Float		Display value 20	x	x
1140	1139	0x0473						
1141	1140	0x0474	2	Float		Display value 21	x	x
1142	1141	0x0475						
1143	1142	0x0476	2	Float		Display value 22	x	x
1144	1143	0x0477						
1145	1144	0x0478	2	Float		Display value 23	x	x
1146	1145	0x0479						
1147	1146	0x047A	2	Float		Display value 24	x	x
1148	1147	0x047B						
1149	1148	0x047C	2	Float		Display value 25	x	x
1150	1149	0x047D						
1151	1150	0x047E	2	Float		Display value 26	x	x
1152	1151	0x047F						
1153	1152	0x0480	2	Float		Display value 27	x	x
1154	1153	0x0481						
1155	1154	0x0482	2	Float		Display value 28	x	x
1156	1155	0x0483						
1157	1156	0x0484	2	Float		Display value 29	x	x
1158	1157	0x0485						
1159	1158	0x0486	2	Float		Display value 30	x	x
1160	1159	0x0487						

Reg.	Address		Length	Format	Category	Parameters/value	Access	
	Dec.	Hex.					Read	Write
Characteristic: Volume flow								
1161	1160	0x0488	1	UInt		Display C1 unit	x	x
					Value	0: m ³ /h		
					Value	1: l/min		
					Value	2: cfm		
1162	1161	0x0489	2	Float		Display C1 end	x	x
1163	1162	0x048A			Value	0 ... 999999		
1164	1163	0x048B	2	Float		K factor C1	x	x
1165	1164	0x048C			Value	0 ... 9999		
1166	1165	0x048D	2	Float		Air density C1	x	x
1167	1166	0x048E			Value	0.25 ... 2		
1168	1167	0x048F	1	UInt		Formula C1	x	x
					Value	0: Default		
					Value	1: Comefri		
					Value	2: EBM Papst		
					Value	3: Fläkt Woods		
					Value	4: Nicotra Gebhardt		
					Value	5: Rosenberg		
					Value	6: Ziehl-Abegg		
Characteristic: Linear function								
1169	1168	0x0490	3	Char		Display C1 unit	x	x
1170	1169	0x0491						
1171	1170	0x0492			Value	5 characters		
1172	1171	0x493	2	Float		Display C1 start	x	x
1173	1172	0x494			Value	-999999 ... +999999		
1174	1173	0x495	2	Float		Display C1 end	x	x
1175	1174	0x496			Value	-999999 ... +999999		
1176	1175	0x497	2	Float		Increase C1	x	x
1177	1176	0x498			Value	-10 ... +10		
1178	1177	0x499	2	Float		Offset C1	x	x
1179	1178	0x59A			Value	-999999 ... +999999		

4.3 Configuration channel 2 (differential pressure)

Reg.	Address		Length	Format	Category	Parameters/value	Access	
	Dec.	Hex.					Read	Write
2001	2000	0x07D0	1	UInt		Mode C2	x	x
					Value	0: Linear characteristic		
					Value	1: Flow rate		
					Value	2: Table		
					Value	3: Volume flow		
					Value	4: Linear function		
2002	2001	0x07D1	1	UInt		Measuring range C2 unit	x	x
					Value	0: Pa		
					Value	1: kPa		
					Value	2: MPa		
					Value	3: bar		
					Value	4: mbar		
					Value	5: mmHg		
					Value	6: mmH ₂ O		
					Value	7: inH ₂ O		
					Value	8: psi		
2003	2002	0x07D2	2	Float		Measuring range C2 start	x	x
2004	2003	0x07D3			Value	GMB start...end		
2005	2004	0x07D4	2	Float		Measuring range C2 end	x	x
2006	2005	0x07D5			Value	GMB start...end		
2007	2006	0x07D6	1	UInt		Damping C2	x	x
					Value	0 ... 30 s		
2008	2007	0x07D7	2	Float		Offset C2	x	x
2009	2008	0x07D8			Value	- $\frac{1}{3}$ GMB ... + $\frac{1}{3}$ GMB		
2010	2009	0x07D9	2	Float		Zero-point window C2	x	x
2011	2010	0x07DA			Value	0 ... + $\frac{1}{3}$ GMB		
2012	2011	0x07DB	1	UInt		Limit C2	x	x
					Value	0: Off		
					Value	1: On		
2013	2012	0x07DC	1	SInt		Number format C2	x	x
					Value	0: ± 123456		
					Value	1: ± 12345.6		
					Value	2: ± 1234.45		
					Value	3: ± 123.456		
					Value	4: ± 12.3456		
					Value	5: ± 1.23456		

Reg.	Address		Length	Format	Category	Parameters/value	Access	
	Dec.	Hex.					Read	Write
2014	2013	0x07DD	2	Float		Colour change C2 red–green	x	x
2015	2014	0x07DE						
					Value	MBA –50% ... FW green-red		
2016	2015	0x07DF	2	Float		Colour change C2 green–red	x	x
2017	2016	0x07E0						
					Value	FW red-green ... MBE +50%		
2018	2017	0x07E1	2	Float		Colour change C2 red–yellow	x	x
2019	2018	0x07E2						
					Value	MBA –50% ... FW yellow-green		
2020	2019	0x07E3	2	Float		Colour change C2 yellow–green	x	x
2021	2020	0x07E4						
					Value	FW red-yellow ... FW green-yellow		
2022	2021	0x07E5	2	Float		Colour change C2 green–yellow	x	x
2023	2022	0x07E6						
					Value	FW yellow-green ... FW yellow-red		
2024	2023	0x07E7	2	Float		Colour change C2 yellow–red	x	x
2025	2024	0x07E8						
					Value	FW green-yellow ... MB +50%		
2026	2025	0x07E9	2	Float		Colour change C2 hysteresis	x	x
2027	2026	0x07EA						
					Value	0.1% ... 10% MB		
2028	2027	0x07EB	1	UInt		Colour change C2 delay on	x	x
					Value	0 ... 100 s		
2029	2028	0x07EC	1	UInt		Colour change C2 delay off	x	x
					Value	0 ... 100 s		
Characteristic: Flow rate								
2030	2029	0x07ED	3	Char		Display C2 unit	x	x
2031	2030	0x07EE						
2032	2031	0x07EF						
					Value	5 characters		
2033	2032	0x07F0	2	Float		Display C2 start	x	x
2034	2033	0x07F1						
					Value	–999999 ... +999999		
2035	2034	0x07F2	2	Float		Display C2 end	x	x
2036	2035	0x07F3						
					Value	–999999 ... +999999		
Characteristic: Table								
2037	2036	0x07F4	3	Char		Display C2 unit	x	x
2038	2037	0x07F5						
2039	2038	0x07F6						
					Value	5 characters		

Reg.	Address		Length	Format	Category	Parameters/value	Access	
	Dec.	Hex.					Read	Write
2040	2039	0x07F7	1	UInt		Number of value pairs	x	x
					Value	2 ... 30		
2041	2040	0x07F8	2	Float		Input value 1	x	x
2042	2041	0x07F9			Value	MBA ... MBE		
						<i>(the same range applies to all values below)</i>		
2043	2042	0x07FA	2	Float		Input value 2	x	x
2044	2043	0x07FB						
2045	2044	0x07FC	2	Float		Input value 3	x	x
2046	2045	0x07FD						
2047	2046	0x07FE	2	Float		Input value 4	x	x
2048	2047	0x07FF						
2049	2048	0x0800	2	Float		Input value 5	x	x
2050	2049	0x0801						
2051	2050	0x0802	2	Float		Input value 6	x	x
2052	2051	0x0803						
2053	2052	0x0804	2	Float		Input value 7	x	x
2054	2053	0x0805						
2055	2054	0x0806	2	Float		Input value 8	x	x
2056	2055	0x0807						
2057	2056	0x0808	2	Float		Input value 9	x	x
2058	2057	0x0809						
2059	2058	0x080A	2	Float		Input value 10	x	x
2060	2059	0x080B						
2061	2060	0x080C	2	Float		Input value 11	x	x
2062	2061	0x080D						
2063	2062	0x080E	2	Float		Input value 12	x	x
2064	2063	0x080F						
2065	2064	0x0810	2	Float		Input value 13	x	x
2066	2065	0x0811						
2067	2066	0x0812	2	Float		Input value 14	x	x
2068	2067	0x0813						
2069	2068	0x0814	2	Float		Input value 15	x	x
2070	2069	0x0815						
2071	2070	0x0816	2	Float		Input value 16	x	x
2072	2071	0x0817						
2073	2072	0x0818	2	Float		Input value 17	x	x
2074	2073	0x0819						
2075	2074	0x081A	2	Float		Input value 18	x	x
2076	2075	0x081B						
2077	2076	0x081C	2	Float		Input value 19	x	x
2078	2077	0x081D						
2079	2078	0x081E	2	Float		Input value 20	x	x
2080	2079	0x081F						

Reg.	Address		Length	Format	Category	Parameters/value	Access	
	Dec.	Hex.					Read	Write
2081	2080	0x0820	2	Float		Input value 21	x	x
2082	2081	0x0821						
2083	2082	0x0822	2	Float		Input value 22	x	x
2084	2083	0x0823						
2085	2084	0x0824	2	Float		Input value 23	x	x
2086	2085	0x0825						
2087	2086	0x0826	2	Float		Input value 24	x	x
2088	2087	0x0827						
2089	2088	0x0828	2	Float		Input value 25	x	x
2090	2089	0x0829						
2091	2090	0x082A	2	Float		Input value 26	x	x
2092	2091	0x082B						
2093	2092	0x082C	2	Float		Input value 27	x	x
2094	2093	0x082D						
2095	2094	0x082E	2	Float		Input value 28	x	x
2096	2095	0x082F						
2097	2096	0x0830	2	Float		Input value 29	x	x
2098	2097	0x0831						
2099	2098	0x0832	2	Float		Input value 30	x	x
2100	2099	0x0833						
2101	2100	0x0834	2	Float		Display value 1	x	x
2102	2101	0x0835						
						Value	-999999 ... +999999	
						<i>(the same range applies to all values below)</i>		
2103	2102	0x0836	2	Float		Display value 2	x	x
2104	2103	0x0837						
2105	2104	0x0838	2	Float		Display value 3	x	x
2106	2105	0x0839						
2107	2106	0x083A	2	Float		Display value 4	x	x
2108	2107	0x083B						
2109	2108	0x083C	2	Float		Display value 5	x	x
2110	2109	0x083D						
2111	2110	0x083E	2	Float		Display value 6	x	x
2112	2111	0x083F						
2113	2112	0x0840	2	Float		Display value 7	x	x
2114	2113	0x0841						
2115	2114	0x0842	2	Float		Display value 8	x	x
2116	2115	0x0843						
2117	2116	0x0844	2	Float		Display value 9	x	x
2118	2117	0x0845						
2119	2118	0x0846	2	Float		Display value 10	x	x
2120	2119	0x0847						

Reg.	Address		Length	Format	Category	Parameters/value	Access	
	Dec.	Hex.					Read	Write
2121	2120	0x0848	2	Float		Display value 11	x	x
2122	2121	0x0849						
2123	2122	0x084A	2	Float		Display value 12	x	x
2124	2123	0x084B						
2125	2124	0x084C	2	Float		Display value 13	x	x
2126	2125	0x084D						
2127	2126	0x084E	2	Float		Display value 14	x	x
2128	2127	0x084F						
2129	2128	0x0850	2	Float		Display value 15	x	x
2130	2129	0x0851						
2131	2130	0x0852	2	Float		Display value 16	x	x
2132	2131	0x0853						
2133	2132	0x0854	2	Float		Display value 17	x	x
2134	2133	0x0855						
2135	2134	0x0856	2	Float		Display value 18	x	x
2136	2135	0x0857						
2137	2136	0x0858	2	Float		Display value 19	x	x
2138	2137	0x0859						
2139	2138	0x085A	2	Float		Display value 20	x	x
2140	2139	0x085B						
2141	2140	0x085C	2	Float		Display value 21	x	x
2142	2141	0x085D						
2143	2142	0x085E	2	Float		Display value 22	x	x
2144	2143	0x085F						
2145	2144	0x0860	2	Float		Display value 23	x	x
2146	2145	0x0861						
2147	2146	0x0862	2	Float		Display value 24	x	x
2148	2147	0x0863						
2149	2148	0x0864	2	Float		Display value 25	x	x
2150	2149	0x0865						
2151	2150	0x0866	2	Float		Display value 26	x	x
2152	2151	0x0867						
2153	2152	0x0868	2	Float		Display value 27	x	x
2154	2153	0x0869						
2155	2154	0x086A	2	Float		Display value 28	x	x
2156	2155	0x086B						
2157	2156	0x086C	2	Float		Display value 29	x	x
2158	2157	0x086D						
2159	2158	0x086E	2	Float		Display value 30	x	x
2160	2159	0x086F						

Reg.	Address		Length	Format	Category	Parameters/value	Access	
	Dec.	Hex.					Read	Write
Characteristic: Volume flow								
2161	2160	0x0870	1	UInt		Display C2 unit	x	x
					Value	0: m ³ /h		
					Value	1: l/min		
					Value	2: cfm		
2162	2161	0x0871	2	Float		Display C2 end	x	x
2163	2162	0x0872			Value	0 ... 999999		
2164	2163	0x0873	2	Float		K factor C2	x	x
2165	2164	0x0874			Value	0 ... 9999		
2166	2165	0x0875	2	Float		Air density C2	x	x
2167	2166	0x0876			Value	0.25 ... 2		
2168	2167	0x0877	1	UInt		Formula C2	x	x
					Value	0: Default		
					Value	1: Comefri		
					Value	2: EBM Papst		
					Value	3: Fläkt Woods		
					Value	4: Nicotra Gebhardt		
					Value	5: Rosenberg		
					Value	6: Ziehl-Abegg		
Characteristic: Linear function								
2169	2168	0x0878	3	Char		Display C2 unit	x	x
2170	2169	0x0879						
2171	2170	0x087A			Value	5 characters		
2172	2171	0x087B	2	Float		Display C2 start	x	x
2173	2172	0x087C			Value	-999999 ... +999999		
2174	2173	0x087D	2	Float		Display C2 end	x	x
2175	2174	0x087E			Value	-999999 ... +999999		
2176	2175	0x087F	2	Float		Increase C2	x	x
2177	2176	0x0880			Value	-10 ... +10		
2178	2177	0x0881	2	Float		Offset C2	x	x
2179	2178	0x0882			Value	-999999 ... +999999		

4.4 Configuration channel 3

Reg.	Address		Length	Format	Category	Parameters/value	Access	
	Dec.	Hex.					Read	Write
3001	3000	0x0BB8	1	UInt		Mode C3	x	x
					Value	0: inactive		
					Value	1: Difference		
					Value	2: Dynamic filter monitoring		
					Value	3: Difference + flow rate		
					Value	4: Difference + table		

4.4.1 Mode = inactive

If the mode is set to inactive, the entire channel is 'switched off'.

4.4.2 Mode = difference

Reg.	Address		Length	Format	Category	Parameters/value	Access	
	Dec.	Hex.					Read	Write
3007	3006	0x0BBE	1	UInt		Damping C3	x	x
					Value	0 ... 30 s		
3008	3007	0x0BBF	2	Float		Offset C3	x	x
3009	3008	0x0BC0			Value	- $\frac{1}{3}$ MB ... + $\frac{1}{3}$ MB		
3010	3009	0x0BC1	2	Float		Zero-point window C3	x	x
3011	3010	0x0BC2			Value	0 ... + $\frac{1}{3}$ MB		
3012	3011	0x0BC3	1	UInt		Limit C3	x	x
					Value	0: Off		
					Value	1: On		
3013	3012	0x0BC4	1	UInt		Number format C3	x	x
					Value	0: ± 123456		
					Value	1: ± 12345.6		
					Value	2: ± 1234.45		
					Value	3: ± 123.456		
					Value	4: ± 12.3456		
					Value	5: ± 1.23456		
3014	3013	0x0BC5	2	Float		Colour change C3 red-green	x	x
3015	3014	0x0BC6			Value	MBA -50% ... FW green-red		
3016	3015	0x0BC7	2	Float		Colour change C3 green-red	x	x
3017	3016	0x0BC8			Value	FW red-green ... MBE +50%		
3018	3017	0x0BC9	2	Float		Colour change C3 red-yellow	x	x
3019	3018	0x0BCA			Value	MBA -50% ... FW yellow-green		
3020	3019	0x0BCB	2	Float		Colour change C3 yellow-green	x	x
3021	3020	0x0BCC						

Reg.	Address		Length	Format	Category	Parameters/value	Access	
	Dec.	Hex.					Read	Write
					Value	FW red-yellow ... FW green-yellow		
3022	3021	0x0BCD	2	Float		Colour change C3 green–yellow	x	x
3023	3022	0x0BCE						
					Value	FW yellow-green ... FW yellow-red		
3024	3023	0x0BCF	2	Float		Colour change C3 yellow–red	x	x
3025	3024	0x0BD0						
					Value	FW green-yellow ... MB +50%		
3026	3025	0x0BD1	2	Float		Colour change C3 hysteresis	x	x
3027	3026	0x0BD2						
					Value	0.1% ... 10% MB		
3028	3027	0x0BD3	1	UInt		Colour change C3 delay on	x	x
					Value	0 ... 100 s		
3029	3028	0x0BD4	1	UInt		Colour change C3 delay off	x	x
					Value	0 ... 100 s		
3030	3029	0x0BD5	1	UInt		Display C3 unit	x	x
					Value	0: Pa		
					Value	1: kPa		
					Value	2: MPa		
					Value	3: bar		
					Value	4: mbar		
					Value	5: mmHg		
					Value	6: mmH ₂ O		
					Value	7: inH ₂ O		
					Value	8: psi		
3031	3030	0x0BD6	2	Float		Display C3 start	x	x
3032	3031	0x0BD7						
					Value	–999999 ... +999999		
3033	3032	0x0BD8	2	Float		Display C3 end	x	x
3034	3033	0x0BD9						
					Value	–999999 ... +999999		
3035	3034	0x0BDA	1	UInt		Formula C3	x	x
					Value	0: Channel 1 – Channel 2		
					Value	1: Channel 2 – Channel 1		
					Value	2: Channel 1 + Channel 2		

4.4.3 Mode = diff. + flow rate

Reg.	Address		Length	Format	Category	Parameters/value	Access		
	Dec.	Hex.					Read	Write	
3007	3006	0x0BBE	1	UInt		Damping C3	x	x	
						Value	0 ... 30 s		
3008	3007	0x0BBF	2	Float		Offset C3	x	x	
3009	3008	0x0BC0				Value	- $\frac{1}{3}$ MB ... + $\frac{1}{3}$ MB		
3010	3009	0x0BC1	2	Float		Zero-point window C3	x	x	
3011	3010	0x0BC2				Value	0 ... + $\frac{1}{3}$ MB		
3012	3011	0x0BC3	1	UInt		Limit C3	x	x	
						Value	0: Off		
						Value	1: On		
3013	3012	0x0BC4	1	UInt		Number format C3	x	x	
						Value	0: ± 123456		
						Value	1: ± 12345.6		
						Value	2: ± 1234.45		
						Value	3: ± 123.456		
						Value	4: ± 12.3456		
Value	5: ± 1.23456								
3014	3013	0x0BC5	2	Float		Colour change C3 red-green	x	x	
3015	3014	0x0BC6				Value	MBA -50% ... FW green-red		
3016	3015	0x0BC7	2	Float		Colour change C3 green-red	x	x	
3017	3016	0x0BC8				Value	FW red-green ... MBE +50%		
3018	3017	0x0BC9	2	Float		Colour change C3 red-yellow	x	x	
3019	3018	0x0BCA				Value	MBA -50% ... FW yellow-green		
3020	3019	0x0BCB	2	Float		Colour change C3 yellow-green	x	x	
3021	3020	0x0BCC				Value	FW red-yellow ... FW green-yellow		
3022	3021	0x0BCD	2	Float		Colour change C3 green-yellow	x	x	
3023	3022	0x0BCE				Value	FW yellow-green ... FW yellow-red		
3024	3023	0x0BCF	2	Float		Colour change C3 yellow-red	x	x	
3025	3024	0x0BD0				Value	FW green-yellow ... MB +50%		

Reg.	Address		Length	Format	Category	Parameters/value	Access			
	Dec.	Hex.					Read	Write		
3026	3025	0x0BD1	2	Float		Colour change C3 hysteresis	x	x		
3027	3026	0x0BD2								
					Value	0.1% ... 10% MB				
3028	3027	0x0BD3	1	UInt		Colour change C3 delay on	x	x		
									Value	0 ... 100 s
3029	3028	0x0BD4	1	UInt		Colour change C3 delay off	x	x		
									Value	0 ... 100 s
3030	3029	0x0BD5	1	UInt		Measur. range C3 unit	x	x		
									Value	0: Pa
									Value	1: kPa
									Value	2: MPa
									Value	3: bar
									Value	4: mbar
									Value	5: mmHg
									Value	6: mmH ₂ O
									Value	7: inH ₂ O
			Value	8: psi						
3031	3030	0x0BD6	2	Float		Measur. range C3 start	x	x		
3032	3031	0x0BD7							Value	-999999 ... +999999
3033	3032	0x0BD8	2	Float		Measur. range C3 end	x	x		
3034	3033	0x0BD9							Value	-999999 ... +999999
3035	3034	0x0BDA	1	UInt		Formula C3	x	x		
									Value	0: Channel 1 – Channel 2
									Value	1: Channel 2 – Channel 1
									Value	2: Channel 1 + Channel 2
3117	3116	0x0C2C	3	Char		Display C3 unit	x	x		
3118	3117	0x0C2D								
3119	3118	0x0C2E							Value	Max. 5 characters
3120	3119	0x0C2F	2	Float		Display C3 start	x	x		
3121	3120	0x0C30							Value	-999999 ... +999999
3122	3121	0x0C31	2	Float		Display C3 end	x	x		
3123	3122	0x0C32							Value	-999999 ... +999999

4.4.4 Mode = diff. + table

Reg.	Address		Length	Format	Category	Parameters/value	Access		
	Dec.	Hex.					Read	Write	
3007	3006	0x0BBE	1	UInt		Damping C3	x	x	
						Value	0 ... 30 s		
3008	3007	0x0BBF	2	Float		Offset C3	x	x	
3009	3008	0x0BC0				Value	- $\frac{1}{3}$ MB ... + $\frac{1}{3}$ MB		
3010	3009	0x0BC1	2	Float		Zero-point window C3	x	x	
3011	3010	0x0BC2				Value	0 ... + $\frac{1}{3}$ MB		
3012	3011	0x0BC3	1	UInt		Limit C3	x	x	
						Value	0: Off		
						Value	1: On		
3013	3012	0x0BC4	1	UInt		Number format C3	x	x	
						Value	0: ± 123456		
						Value	1: ± 12345.6		
						Value	2: ± 1234.45		
						Value	3: ± 123.456		
						Value	4: ± 12.3456		
Value	5: ± 1.23456								
3014	3013	0x0BC5	2	Float		Colour change C3 red-green	x	x	
3015	3014	0x0BC6				Value	MBA -50% ... FW green-red		
3016	3015	0x0BC7	2	Float		Colour change C3 green-red	x	x	
3017	3016	0x0BC8				Value	FW red-green ... MBE +50%		
3018	3017	0x0BC9	2	Float		Colour change C3 red-yellow	x	x	
3019	3018	0x0BCA				Value	MBA -50% ... FW yellow-green		
3020	3019	0x0BCB	2	Float		Colour change C3 yellow-green	x	x	
3021	3020	0x0BCC				Value	FW red-yellow ... FW green-yellow		
3022	3021	0x0BCD	2	Float		Colour change C3 green-yellow	x	x	
3023	3022	0x0BCE				Value	FW yellow-green ... FW yellow-red		
3024	3023	0x0BCF	2	Float		Colour change C3 yellow-red	x	x	
3025	3024	0x0BD0				Value	FW green-yellow ... MB +50%		

Reg.	Address		Length	Format	Category	Parameters/value	Access			
	Dec.	Hex.					Read	Write		
3026	3025	0x0BD1	2	Float		Colour change C3 hysteresis	x	x		
3027	3026	0x0BD2								
					Value	0.1% ... 10% MB				
3028	3027	0x0BD3	1	UInt		Colour change C3 delay on	x	x		
									Value	0 ... 100 s
3029	3028	0x0BD4	1	UInt		Colour change C3 delay off	x	x		
									Value	0 ... 100 s
3030	3029	0x0BD5	1	UInt		Measur. range C3 unit	x	x		
									Value	0: Pa
									Value	1: kPa
									Value	2: MPa
									Value	3: bar
									Value	4: mbar
									Value	5: mmHg
									Value	6: mmH ₂ O
									Value	7: inH ₂ O
			Value	8: psi						
3031	3030	0x0BD6	2	Float		Measur. range C3 unit	x	x		
3032	3031	0x0BD7								
					Value	-999999 ... +999999				
3033	3032	0x0BD8	2	Float		Measur. range C3 start	x	x		
3034	3033	0x0BD9								
					Value	-999999 ... +999999				
3035	3034	0x0BDA	1	UInt		Formula C3	x	x		
									Value	0: Channel 1 – Channel 2
									Value	1: Channel 2 – Channel 1
									Value	2: Channel 1 + Channel 2
3124	3123	0x0C33	3	Char		Display C3 unit	x	x		
3125	3124	0x0C34								
3126	3125	0x0C35								
					Value	Max. 5 characters				
3127	3126	0x0C36	1	UInt		Number of value pairs	x	x		
									Value	2 ... 30
3128	3127	0x0C37	2	Float		Input value 1	x	x		
3129	3128	0x0C38								
					Value	MBA ... MBE				
						<i>(the same range applies to all values below)</i>				
3130	3129	0x0C39	2	Float		Input value 2	x	x		
3131	3130	0x0C3A								
3132	3131	0x0C3B	2	Float		Input value 3	x	x		
3133	3132	0x0C3C								
3134	3133	0x0C3D	2	Float		Input value 4	x	x		
3135	3134	0x0C3E								

Reg.	Address		Length	Format	Category	Parameters/value	Access	
	Dec.	Hex.					Read	Write
3136	3135	0x0C3F	2	Float		Input value 5	x	x
3137	3134	0x0C40						
3138	3137	0x0C41	2	Float		Input value 6	x	x
3139	3138	0x0C42						
3140	3139	0x0C43	2	Float		Input value 7	x	x
3141	3140	0x0C44						
3142	3141	0x0C45	2	Float		Input value 8	x	x
3143	3142	0x0C46						
3144	3143	0x0C47	2	Float		Input value 9	x	x
3145	3144	0x0C48						
3146	3145	0x0C49	2	Float		Input value 10	x	x
3147	3146	0x0C4A						
3148	3147	0x0C4B	2	Float		Input value 11	x	x
3149	3148	0x0C4C						
3150	3149	0x0C4D	2	Float		Input value 12	x	x
3151	3150	0x0C4E						
3152	3151	0x0C4F	2	Float		Input value 13	x	x
3153	3152	0x0C50						
3154	3153	0x0C51	2	Float		Input value 14	x	x
3155	3154	0x0C52						
3156	3155	0x0C53	2	Float		Input value 15	x	x
3157	3156	0x0C54						
3158	3157	0x0C55	2	Float		Input value 16	x	x
3159	3158	0x0C56						
3160	3159	0x0C57	2	Float		Input value 17	x	x
3161	3160	0x0C58						
3162	3161	0x0C59	2	Float		Input value 18	x	x
3163	3162	0x0C5A						
3164	3163	0x0C5B	2	Float		Input value 19	x	x
3165	3164	0x0C5C						
3166	3165	0x0C5D	2	Float		Input value 20	x	x
3167	3166	0x0C5E						
3168	3167	0x0C5F	2	Float		Input value 21	x	x
3169	3168	0x0C60						
3170	3169	0x0C61	2	Float		Input value 22	x	x
3171	3170	0x0C62						
3172	3171	0x0C63	2	Float		Input value 23	x	x
3173	3172	0x0C64						
3174	3173	0x0C65	2	Float		Input value 24	x	x
3175	3174	0x0C66						
3176	3175	0x0C67	2	Float		Input value 25	x	x
3177	3176	0x0C68						
3178	3177	0x0C69	2	Float		Input value 26	x	x
3179	3178	0x0C6A						

Reg.	Address		Length	Format	Category	Parameters/value	Access	
	Dec.	Hex.					Read	Write
3180	3179	0x0C6B	2	Float		Input value 27	x	x
3181	3180	0x0C6C						
3182	3181	0x0C6D	2	Float		Input value 28	x	x
3183	3182	0x0C6E						
3184	3183	0x0C6F	2	Float		Input value 29	x	x
3185	3184	0x0C70						
3186	3185	0x0C71	2	Float		Input value 30	x	x
3187	3186	0x0C72						
3188	3187	0x0C73	2	Float		Output value 1	x	x
3189	3188	0x0C74						
					Value	MBA ... MBE		
						<i>(the same range applies to all values below)</i>		
3190	3189	0x0C75	2	Float		Output value 2	x	x
3191	3190	0x0C76						
3192	3191	0x0C77	2	Float		Output value 3	x	x
3193	3192	0x0C78						
3194	3193	0x0C79	2	Float		Output value 4	x	x
3195	3194	0x0C7A						
3196	3195	0x0C7B	2	Float		Output value 5	x	x
3197	3196	0x0C7B						
3198	3197	0x0C7D	2	Float		Output value 6	x	x
3199	3198	0x0C7E						
3200	3199	0x0C7F	2	Float		Output value 7	x	x
3201	3200	0x0C80						
3202	3201	0x0C81	2	Float		Output value 8	x	x
3203	3202	0x0C82						
3204	3203	0x0C83	2	Float		Output value 9	x	x
3205	3204	0x0C84						
3206	3205	0x0C85	2	Float		Output value 10	x	x
3207	3206	0x0C86						
3208	3207	0x0C87	2	Float		Output value 11	x	x
3209	3208	0x0C88						
3210	3209	0x0C89	2	Float		Output value 12	x	x
3211	3210	0x0C8A						
3212	3211	0x0C8B	2	Float		Output value 13	x	x
3213	3212	0x0C8C						
3214	3213	0x0C8D	2	Float		Output value 14	x	x
3215	3214	0x0C8E						
3216	3215	0x0C8F	2	Float		Output value 15	x	x
3217	3216	0x0C90						
3218	3217	0x0C91	2	Float		Output value 16	x	x
3219	3218	0x0C92						
3220	3219	0x0C93	2	Float		Output value 17	x	x
3221	3220	0x0C94						

Reg.	Address		Length	Format	Category	Parameters/value	Access	
	Dec.	Hex.					Read	Write
3222	3221	0x0C95	2	Float		Output value 18	x	x
3223	3222	0x0C96						
3224	3223	0x0C97	2	Float		Output value 19	x	x
3225	3224	0x0C98						
3226	3225	0x0C99	2	Float		Output value 20	x	x
3227	3226	0x0C9A						
3228	3227	0x0C9B	2	Float		Output value 21	x	x
3229	3228	0x0C9C						
3230	3229	0x0C9D	2	Float		Output value 22	x	x
3231	3230	0x0C9E						
3232	3231	0x0C9F	2	Float		Output value 23	x	x
3233	3232	0x0C10						
3234	3233	0x0CA1	2	Float		Output value 24	x	x
3235	3234	0x0CA2						
3236	3235	0x0CA3	2	Float		Output value 25	x	x
3237	3236	0x0CA4						
3238	3237	0x0CA5	2	Float		Output value 26	x	x
3239	3238	0x0CA6						
3240	3239	0x0CA7	2	Float		Output value 27	x	x
3241	3240	0x0CA8						
3242	3241	0x0CA9	2	Float		Output value 28	x	x
3243	3242	0x0CAA						
3244	3243	0x0CAB	2	Float		Output value 29	x	x
3245	3244	0x0CAC						
3246	3245	0x0CAD	2	Float		Output value 30	x	x
3247	3246	0x0CAE						

4.4.5 Mode = Dyn. filter monitoring

Reg.	Address		Length	Format	Category	Parameters/value	Access		
	Dec.	Hex.					Read	Write	
3012	3011	0x0BC3	1	UInt		Limit C3	x	x	
						Value	0: Off		
						Value	1: On		
3013	3012	0x0BC4	1	UInt		Number format C3	x	x	
						Value	0: ±123456		
						Value	1: ±12345.6		
						Value	2: ±1234.45		
						Value	3: ±123.456		
						Value	4: ±12.3456		
						Value	5: ±1.23456		
3014	3013	0x0BC5	2	Float		Colour change C3 red–green	x	x	
3015	3014	0x0BC6				Value	MBA –50% ... FW green-red		
3016	3015	0x0BC7	2	Float		Colour change C3 green–red	x	x	
3017	3016	0x0BC8				Value	FW red-green ... MBE +50%		
3018	3017	0x0BC9	2	Float		Colour change C3 red–yellow	x	x	
3019	3018	0x0BCA				Value	MBA –50% ... FW yellow-green		
3020	3019	0x0BCB	2	Float		Colour change C3 yellow–green	x	x	
3021	3020	0x0BCC				Value	FW red-yellow ... FW green-yellow		
3022	3021	0x0BCD	2	Float		Colour change C3 green–yellow	x	x	
3023	3022	0x0BCE				Value	FW yellow-green ... FW yellow-red		
3024	3023	0x0BCF	2	Float		Colour change C3 yellow–red	x	x	
3025	3024	0x0BD0				Value	FW green-yellow ... MB +50%		
3026	3025	0x0BD1	2	Float		Colour change C3 hysteresis	x	x	
3027	3026	0x0BD2				Value	0.1% ... 10% MB		
3028	3027	0x0BD3	1	UInt		Colour change C3 delay on	x	x	
						Value	0 ... 100 s		
3029	3028	0x0BD4	1	UInt		Colour change C3 delay off	x	x	
						Value	0 ... 100 s		

Reg.	Address		Length	Format	Category	Parameters/value	Access	
	Dec.	Hex.					Read	Write
3036	3035	0x0BDB	2	Float		Display C3 start	x	x
3037	3036	0x0BDC						
					Value	-999999 ... +999999		
3038	3037	0x0BDD	2	Float		Display C3 end	x	x
3039	3038	0x0BDE						
					Value	-999999 ... +999999		
3040	3039	0x0BDF	1	UInt		Channel Δp	x	x
					Value	2: Channel 2		
3041	3040	0x0BE0	1	UInt		Channel Q	x	x
					Value	2: Channel 2		
3042	3041	0x0BE1	1	UInt		Approximation	x	x
					Value	2: square root		
3043	3042	0x0BE2	2	Float		Δp clean	x	x
3044	3043	0x0BE3						
					Value	0 ... +999999		
3045	3044	0x0BE4	2	Float		Δp soiled	x	x
3046	3045	0x0BE5						
					Value	0 ... +999999		
3047	3046	0x0BE6	2	Float		Δp correction value	x	x
3048	3047	0x0BE7						
					Value	-999999 ... +999999		
3049	3048	0x0BE8	2	Float		Max. volume flow	x	x
3050	3049	0x0BE9						
					Value	0 ... +999999		
3051	3050	0x0BEA	2	Float		Min. volume flow	x	x
3052	3051	0x0BEB						
					Value	0 ... 50% max. volume flow		
3053	3052	0x0BEC	1	UInt		Number of value pairs	x	x
					Value	2 ... 10		
3054	3053	0x0BED	2	Float		Δp 1	x	x
3055	3054	0x0BEE						
					Value	-999999 ... +999999		
						<i>(the same range applies to all values below)</i>		
3056	3055	0x0BEF	2	Float		Δp 2	x	x
3057	3056	0x0BF0						
3058	3057	0x0BF1	2	Float		Δp 3	x	x
3059	3058	0x0BF2						
3060	3059	0x0BF3	2	Float		Δp 4	x	x
3061	3060	0x0BF4						
3062	3061	0x0BF5	2	Float		Δp 5	x	x
3063	3062	0x0BF6						

Reg.	Address		Length	Format	Category	Parameters/value	Access	
	Dec.	Hex.					Read	Write
3064	3063	0x0BF7	2	Float		Δp 6	x	x
3065	3064	0x0BF8						
3066	3065	0x0BF9	2	Float		Δp 7	x	x
3067	3066	0x0BFA						
3068	3067	0x0BFB	2	Float		Δp 8	x	x
3069	3068	0x0BFC						
3070	3069	0x0BFD	2	Float		Δp 9	x	x
3071	3070	0x0BFE						
3072	3071	0x0BFF	2	Float		Δp 10	x	x
3073	3072	0x0C00						
3074	3073	0x0C01	2	Float		Volume flow 1	x	x
3075	3074	0x0C02						
						Value	-999999 ... +999999	
						<i>(the same range applies to all values below)</i>		
3076	3075	0x0C03	2	Float		Volume flow 2	x	x
3077	3076	0x0C04						
3078	3077	0x0C05	2	Float		Volume flow 3	x	x
3079	3078	0x0C06						
3080	3079	0x0C07	2	Float		Volume flow 4	x	x
3081	3080	0x0C08						
3082	3081	0x0C09	2	Float		Volume flow 5	x	x
3083	3082	0x0C0A						
3084	3083	0x0C0B	2	Float		Volume flow 6	x	x
3085	3084	0x0C0C						
3086	3085	0x0C0D	2	Float		Volume flow 7	x	x
3087	3086	0x0C0E						
3088	3087	0x0C0F	2	Float		Volume flow 8	x	x
3089	3088	0x0C10						
3090	3089	0x0C11	2	Float		Volume flow 9	x	x
3091	3090	0x0C12						
3092	3091	0x0C13	2	Float		Volume flow 10	x	x
3093	3092	0x0C14						
3094	3093	0x0C15	2	Float		Contamination 1	x	x
3095	3094	0x0C16						
						Value	-999999 ... +999999	
						<i>(the same range applies to all values below)</i>		
3096	3095	0x0C17	2	Float		Contamination 2	x	x
3097	3096	0x0C18						
3098	3097	0x0C19	2	Float		Contamination 3	x	x
3099	3098	0x0C1A						
3100	3099	0x0C1B	2	Float		Contamination 4	x	x
3101	3100	0x0C1C						
3102	3101	0x0C1D	2	Float		Contamination 5	x	x
3103	3102	0x0C1E						

Reg.	Address		Length	Format	Category	Parameters/value	Access	
	Dec.	Hex.					Read	Write
3104	3103	0x0C1F	2	Float		Contamination 6	x	x
3105	3104	0x0C20						
3106	3105	0x0C21	2	Float		Contamination 7	x	x
3107	3106	0x0C22						
3108	3107	0x0C23	2	Float		Contamination 8	x	x
3109	3108	0x0C24						
3110	3109	0x0C25	2	Float		Contamination 9	x	x
3111	3110	0x0C26						
3112	3111	0x0C27	2	Float		Contamination 10	x	x
3113	3112	0x0C28						
3114	3113	0x0C29	2	Float		Min. contamination	x	x
3115	3114	0x0C2A						
					Value	-999999 ... +999999		
3116	3115	0x0C2B	1	UInt		Damping C3	x	x

4.5 Configuration of switch outputs

Reg.	Address		Length	Format	Category	Parameters/value	Access	
	Dec.	Hex.					Read	Write
6001	6000	0x1770	1	UInt		SP1 assignment	x	x
					Value	0: inactive		
					Value	1: Channel 1		
					Value	2: Channel 2		
					Value	3: Channel 3		
6002	6001	0x1771	2	Float		SP1 On	x	x
6003	6002	0x1772			Value	MBA -50% ... MBE +50%		
6004	6003	0x1773	2	Float		SP1 Off	x	x
6005	6004	0x1774			Value	MBA -50% ... MBE +50%		
6006	6005	0x1775	1	UInt		SP1 delay on	x	x
					Value	0 ... 1800 s		
6007	6006	0x1776	1	UInt		SP1 delay off	x	x
					Value	0 ... 1800 s		
6008	6007	0x1777	1	UInt		SP1 function	x	x
					Value	0: normally open	x	x
					Value	1: normally closed	x	x
6009	6008	0x1778	1	UInt		SP2 assignment	x	x
					Value	0: inactive		
					Value	1: Channel 1		
					Value	2: Channel 2		
					Value	3: Channel 3		
6010	6009	0x1779	2	Float		SP2 On	x	x
6011	6010	0x177A			Value	MBA -50% ... MBE +50%		
6012	6011	0x177B	2	Float		SP2 Off	x	x
6013	6012	0x177C			Value	MBA -50% ... MBE +50%		
6014	6013	0x177D	1	UInt		SP2 delay on	x	x
					Value	0 ... 1800 s		
6015	6014	0x177E	1	UInt		SP2 delay off	x	x
					Value	0 ... 1800 s		
6016	6015	0x177F	1	UInt		SP2 Function	x	x
					Value	0: normally open	x	x
					Value	1: normally closed	x	x
6017	6016	0x1780	1	UInt		SP3 assignment	x	x
					Value	0: inactive		
					Value	1: Channel 1		
					Value	2: Channel 2		
					Value	3: Channel 3		
6018	6017	0x1781	2	Float		SP3 On	x	x
6019	6018	0x1782			Value	MBA -50% ... MBE +50%		

Reg.	Address		Length	Format	Category	Parameters/value	Access	
	Dec.	Hex.					Read	Write
6020	6019	0x1783	2	Float		SP3 Off	x	x
6021	6020	0x1784			Value	MBA -50% ... MBE +50%		
6022	6021	0x1785	1	UInt		SP3 delay on	x	x
					Value	0 ... 1800 s		
6023	6022	0x1786	1	UInt		SP2 delay off	x	x
					Value	0 ... 1800 s		
6024	6023	0x1787	1	UInt		SP3 function	x	x
					Value	0: normally open	x	x
					Value	1: normally closed	x	x
6025	6024	0x1788	1	UInt		SP4 assignment	x	x
					Value	0: inactive		
					Value	1: Channel 1		
					Value	2: Channel 2		
					Value	3: Channel 3		
6026	6025	0x1789	2	Float		SP4 On	x	x
6027	6024	0x178A			Value	MBA -50% ... MBE +50%		
6028	6027	0x178B	2	Float		SP4 Off	x	x
6029	6028	0x178C			Value	MBA -50% ... MBE +50%		
6030	6029	0x178D	1	UInt		SP4 delay on	x	x
					Value	0 ... 1800 s		
6031	6030	0x178E	1	UInt		SP4 delay off	x	x
					Value	0 ... 1800 s		
6032	6031	0x178F	1	UInt		SP4 function	x	x
					Value	0: normally open	x	x
					Value	1: normally closed	x	x

4.6 Configuration display

Reg.	Address		Length	Format	Category	Measured values	Access			
	Dec.	Hex.					Read	Write		
7001	7000	0x1B58	1	UInt		Language	x	x		
					Value	0: German				
					Value	1: English				
					Value	2: Spanish				
					Value	3: French				
					Value	4: Italian				
					Value	5: Portuguese				
					Value	6: Hungarian				
7002	7001	0x1B59	10	Char		Designation	x	x		
7003	7002	0x1B5A								
7004	7003	0x1B5B								
7005	7004	0x1B5C								
7006	7005	0x1B5D								
7007	7006	0x1B5E								
7008	7007	0x1B5F								
7009	7008	0x1B60								
7010	7009	0x1B61								
7011	7010	0x1B62								
							Value	20 characters		
7012	7011	0x1B63						reserved		
7013	7012	0x1B64	1	UInt		Meas. data display	x	x		
					Value	1: Channel 1				
					Value	2: Channel 2				
					Value	4: Channel 3				
					Value	255: All channels				
7014	7013	0x1B65	1	UInt		Colour change assignment	x	x		
					Bit 0	Channel 1				
					Bit 1	Channel 2				
					Bit 2	Channel 3				
7015	7014	0x1B66	1	UInt		LCD colour	x	x		
					Value	0: Off				
					Value	1: green				
					Value	2: blue				
					Value	3: white				
					Value	4: red				
					Value	5: red/green (colour change)				
					Value	6: red/yellow/green (colour change)				
					Value	7: cyan				
					Value	8: yellow				
					Value	9: magenta				
7016	7015	0x1B67	1	UInt		LCD lighting	x	x		
					Value	0 ... 600 s				
7017	7016	0x1B68	1	UInt		LCD contrast	x	x		
					Value	-15 ... +15				

4.7 Error indicator

Reg.	Address		Length	Format	Category	Measured values	Access	
	Dec.	Hex.					Read	Write
9999	9998	0x270E	1	UInt		Error indicator configuration	x	

If an invalid value is written in a register, its original value is retained. The number of the first invalid parameter can be called up via the Register 9999. If a zero (0) is saved here, the last written configuration is valid.

5 Attachments

5.1 Literature

„IEEE Standard for Floating-Point Arithmetic.“ 29. 08 2008.

<<http://ieeexplore.ieee.org/document/4610935/>>.

„Modbus Application Protocol v1.1b3.“ 26. 04 2012.

<http://www.modbus.org/docs/Modbus_Application_Protocol_V1_1b3.pdf>.

Glossary

ADU

The Application Data Unit (ADU) is the complete command / data block of the communication protocol.

char

Abbreviation for character Char as a data type defines that the individual characters of a memory area each comprise (usually) 8 bits that represent a displayable character (letter, digit, special character...). The content of the memory point states which sign this is.

EIA-485

EIA-485, also called RS-485, is an industrial standard for an interface with asynchronous serial data transmission.

IEEE-475

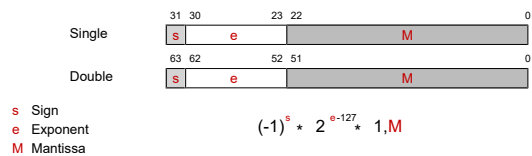

The IEEE754 standard stipulates several data formats. The most important are the single and the double format. These formats comprise a sign bit s, the exponent e and the mantissa m.

Master/Slave

Master/Slave is a type of hierarchical administration of access to a common resource usually in the shape of a common data channel. A participant is the Master, all others are the Slaves. The Master is the only one authorised to access the joint resource without request. The Slave cannot access the common resource on its own; it must wait until it is requested by the Master.

Message

Process of the transmission of data between a sender and one or more recipients.

PDU

The Protocol Data Unit (PDU) is the data block of a message.

Request

The request by a Master to a Slave to carry out the Function Code the transmission contains.

Response

Response by the Slave to the Master to a Request.

RTU

Remote Terminal Unit

Transaction

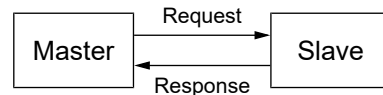

A transaction comprises a request from the Master and a response from the Slave.



FISCHER Mess- und Regeltechnik GmbH

Bielefelder Str. 37a
D-32107 Bad Salzuflen

Tel. +49 5222 974-0

Fax +49 5222 7170

www.fischermesstechnik.de

info@fischermesstechnik.de